

One way flow control valve with Indicator and Push-lock knob

Secure Lock

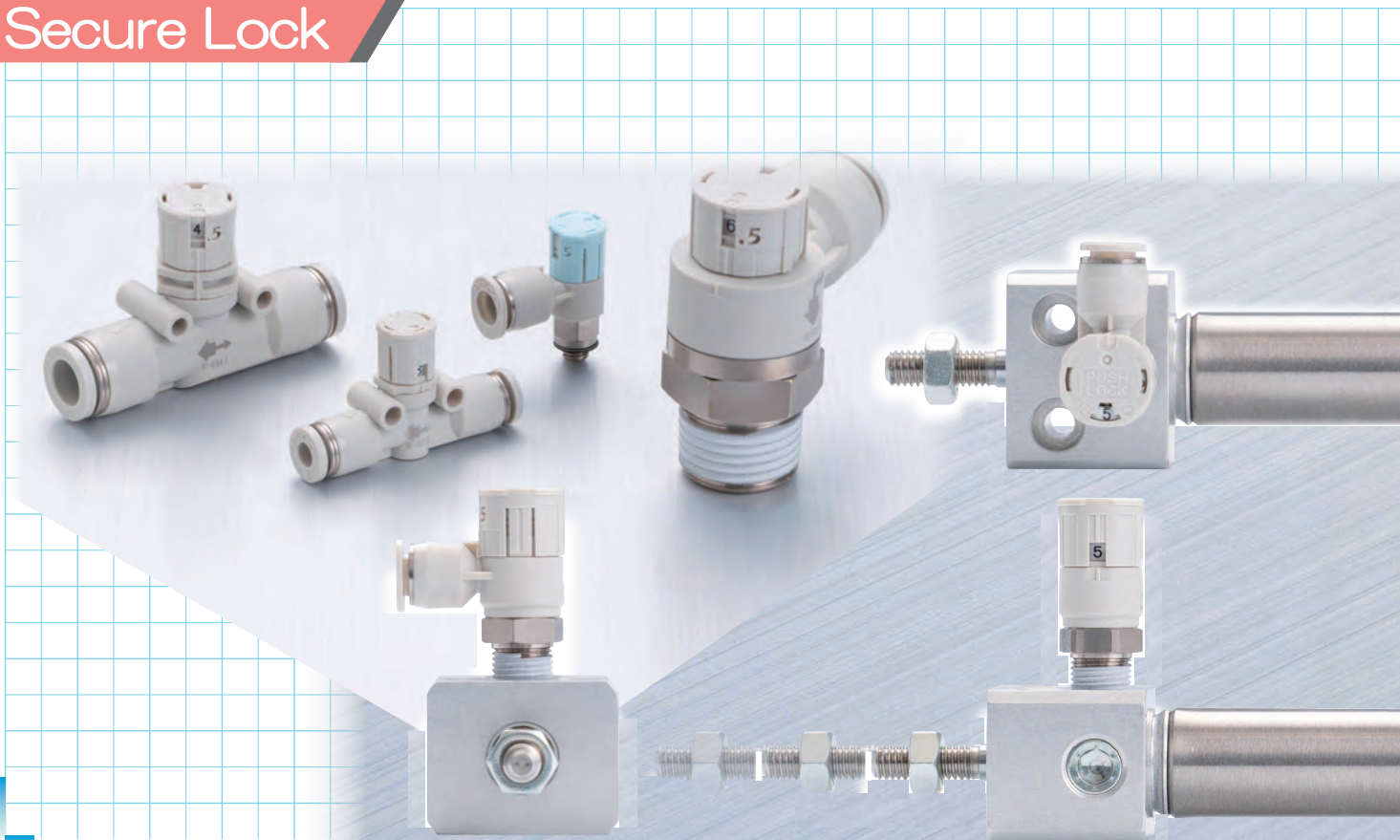

Reducing the task of **initial settings** and making their **maintenances & replacements easier!**

- 1 Indicator shows every 1/2 turn
- 2 Extreme compact • Low profile !
- 3 Linear characteristic permits easy adjustments

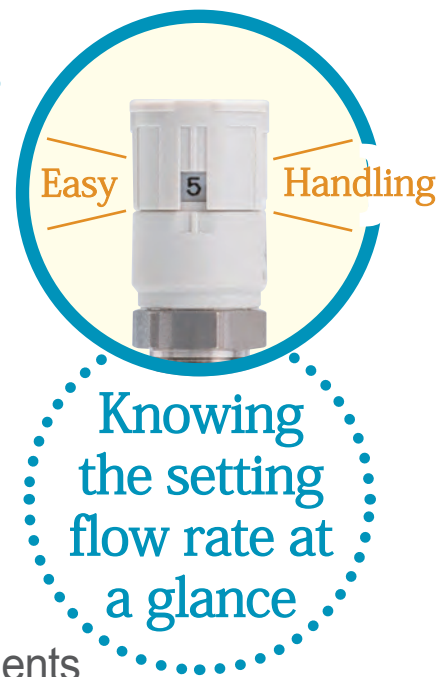

Features

The flow rate is recognized by the indicator

Turns open is on the side (upper/lower windows) and on the top (※)



Linear flow characteristic: Flow rate changes linearly in proportion to the turns of knob.

The low flow type which enables fine adjustments is provided.

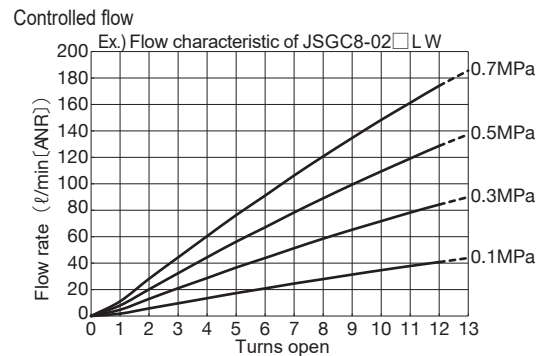

Miniaturized!

As a flow control valve with indicator, **the most compact and the lowest profile!**

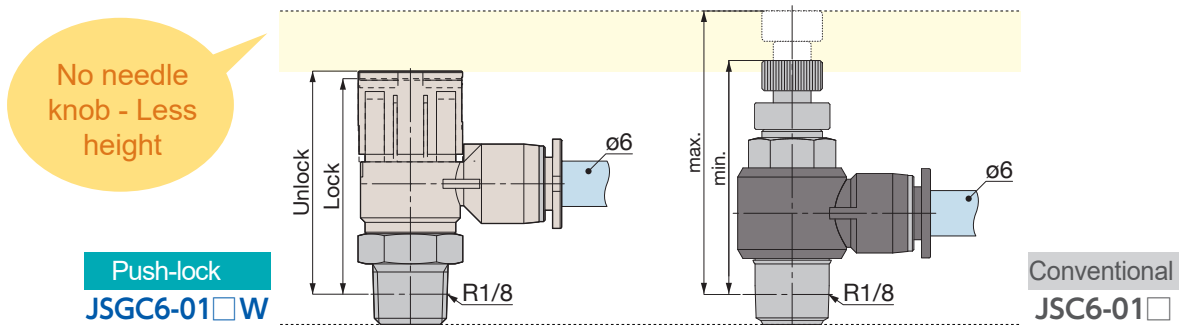

Push-Lock type knob - Easy to handle

Flow rate can be set by 30 steps in one turn (However, the number of rotation is visible every 1/2 turn)



The direction of air flow is identified by the knob color

Meter-out control
Best suitable for controlling the speed of double-acting cylinder

Meter-in control
Best suitable for controlling the speed of single-acting cylinder



The rubber material of diaphragm is HNBR

Model Designation (Example)

JSG **C** **1/4** - **N1** **A** **5** **W**

Push-Lock type Flow Control valve with Indicator

Color : Light gray

⑤. Flow rate type

Code	No entry	L
Type	Standard	Low flow
I.D.	—	Letter "L" engraved

④. Control Direction (※No entry for JSGU : In-Line straight)

Code	A		B		No entry
Control	Meter-out Control (Exhaust control)		Meter-in Control (Air supply control)		
Coloring	Knob color	Symol on body	Knob color	Symol on body	
	Light gray		Light blue		

③. Thread size (※No entry for JSGU : In-Line straight)

	Unified thread		National pipe thread			
Code	U10	N1	N2	N3	N4	
Thread size	10-32UNF	NPT1/8	NPT1/4	NPT3/8	NPT1/2	

	Metric thread		British tapered pipe thread			
Code	M3	M5	O1	O2	O3	O4
Thread size	M3×0.5	M5×0.8	R1/8	R1/4	R3/8	R1/2

②. Tubing size

■ Inch size

Code	1/8	5/32	1/4	5/16	3/8	1/2
Tubing O.D. (in.)	ø1/8	ø5/32	ø1/4	ø5/16	ø3/8	ø1/2

■ Metric size

Code	3	4	6	8	10	12
Tubing O.D. (mm)	ø3	ø4	ø6	ø8	ø10	ø12

①. Type

Code	C	U	S
Type	Elbow	In-Line	Universal
			Newly added

Specification

Fluid medium	Air
Service pressure range	14.5 ~ 145psi (0.1~1.0MPa)
Diaphragm opening pressure	7.25psi (0.05MPa)
Service temperature range	32 ~ 140°F (0~60°C) (no freezing)

See the products section for details

http://pisco.com/products/Push_Lock_Flow_Control

Push-Lock type Flow control valve with Indicator

Structure

■ In-Line straight type (JSGU)

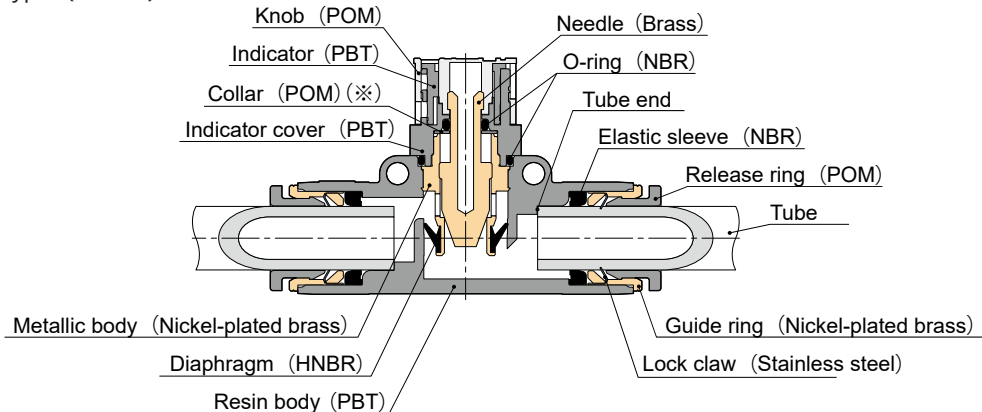

※) For Tube dia. : $\phi 12\text{mm}$ and $\phi 1/2"$ only.

■ Elbow type (JSGC)

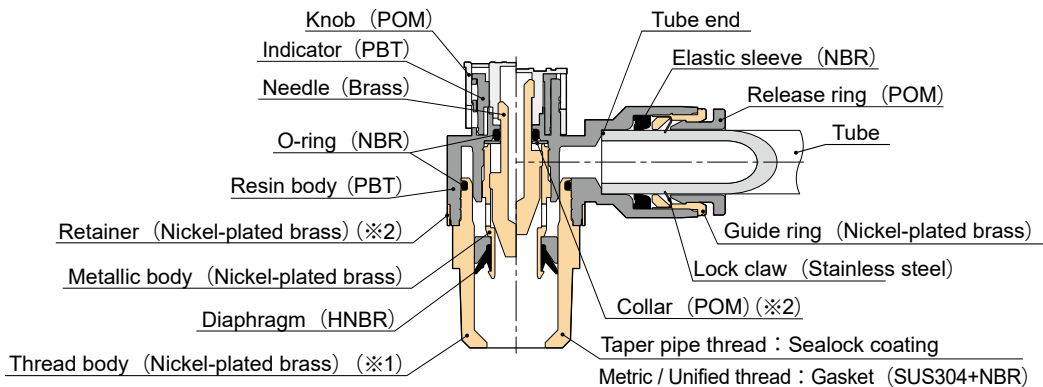

※ 1) For M3 thread : Special stainless steel (Austenite or ferritic stainless steel with SUS303 equivalent corrosivity)

※ 2) For thread size : 04 (R1/2) and N4 (NPT1/2) only.

△ Safety instruction

- △ Caution
1. When setting the speed of actuators, open the air gradually by turning the needle from the fully-closed position. Otherwise, the actuators can pop or cause unplanned movements. Turn the needle in the clockwise direction to close, and in the counterclockwise to open.
 2. Do not swivel/rotate the upper portion of the valve body while it is pressurized. Doing so will damage the diaphragm and cause air leakage.
- △ Remarks
1. Flow control valve permits some air leakage. Do not use for the application which requires no leakage.
 2. Flow characteristics are for reference. The value will differ depending on piping, circuit, pressure and so on.
 3. Push the adjusting knob to lock and pull to release. Make sure to push the knob otherwise the knob can turn and the flow rate may change.
 4. When pushing down on the adjusting knob, it could sit in the middle position between 'locked' and 'released'. In this situation, the valve is not locked. Please make sure the adjusting knob is fully pushed in the 'lock' position.
 5. Do not turn the knob when it is in the pushed position. Otherwise it may cause a damage on the locking mechanism.
 6. When the needle is in the fully-open position, do not rotate the adjusting knob counter-clockwise; also, when the needle is in the fully-closed position, do not rotate the knob clockwise. Doing so may/will damage the adjusting knob and the main body.
 7. The adjusting range (turns) of needle differs by the size. Please refer to the chart 1 and make sure turning the needle within the range watching the number showed in the indicator windows. Excessive needle turning may cause a damage or a malfunction.

Chart 1. Adjusting range

Model	Thread size	
	Straight thread (Unified & Metric)	Taper pipe thread
Elbow type	10-32UNF, M3×0.5, M5×0.8	1/8NPT, 1/4NPT, 3/8NPT, 1/2NPT, R1/8, R1/4, R3/8, R1/2
Adjusting range (Turns)	0~7	0~12
Model	Tubing O.D.	
	In-Line straight type	5/32", $\phi 3$, $\phi 4$
Adjusting range (Turns)	0~7	0~12

Dimensions

JSGU In-Line Straight

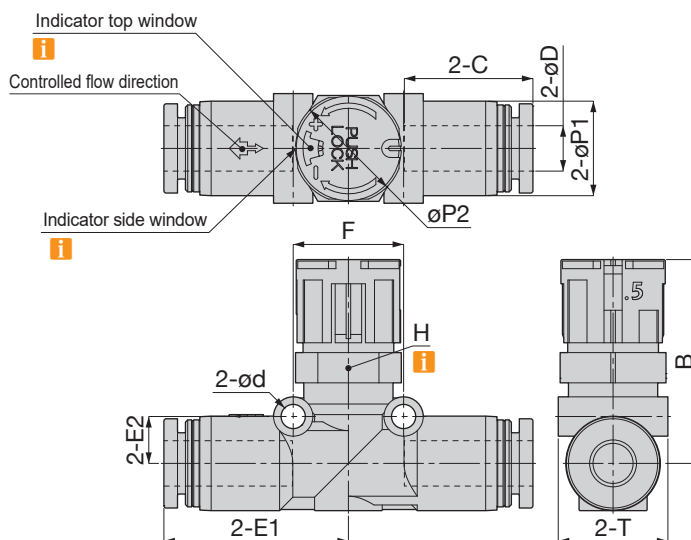

Inch models

Unit : mm

Model	Tube O.D. øD	B		øP1	øP2	Tube End C	E1	E2	Hex. H	ød	F	T	Weight (g)
		Unlock	Lock										
JSGU5/32 [5]W	5/32	20	19.1	10	10.4	14.9	21	5.3	10	3.2	12.7	10.5	8
JSGU1/4 [5]W	1/4	27	26	12.5	14.4	17	24.4	6.2	14	3.2	14.8	14.5	14
JSGU5/16 [5]W	5/16	28.5	27.5	14.8	14.4	18.1	28	8.4	14	3.2	18.2	15.4	20
JSGU3/8 [5]W	3/8	32	30.8	18.2	19.6	20.2	31.8	10.3	19	4.2	22.2	19.7	37
JSGU1/2 [5]W	1/2	35.2	34	21.2	19.6	23.7	37.2	12.2	21	4.2	25.7	22.7	53

Metric models

Unit : mm

Model	Tube O.D. øD	B		øP1	øP2	Tube End C	E1	E2	Hex. H	ød	F	T	Weight (g)
		Unlock	Lock										
JSGU4[5]W	4	20	19.1	10	10.4	14.9	21	5.3	10	3.2	12.7	10.5	8
JSGU6[5]W	6	27	26	12.5	14.4	17	24.4	6.2	14	3.2	14.8	14.5	14
JSGU8[5]W	8	28.5	27.5	14.8	14.4	18.1	28	8.4	14	3.2	18.2	15.4	20
JSGU10 [5]W	10	32	30.8	18.2	19.6	20.2	31.8	10.3	19	4.2	22.2	19.7	37
JSGU12 [5]W	12	35.2	34	21.2	19.6	23.4	36.9	12.2	21	4.2	25.7	22.7	54

※) Fill the flow type in [5] referring to the model designation (example) on the previous page

i The indicator windows of In-Line straight type can be rotated 360° by turning the hex. with a wrench.

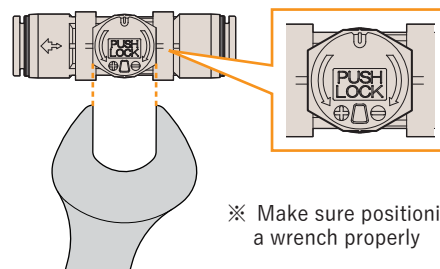

※ Make sure positioning a wrench properly

Push-Lock type Flow control valve with Indicator

Dimensions - NPT & Unified thread

JSGC Elbow



Meter-out control
(Exhaust control)



Meter-out control
(Air supply control)

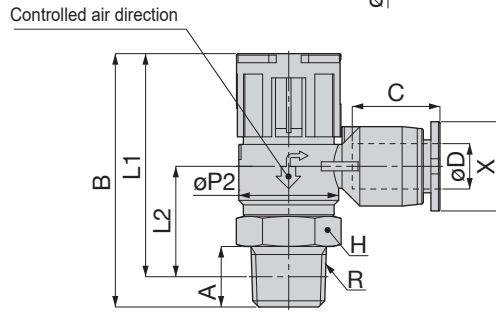
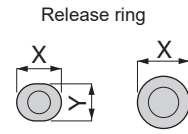
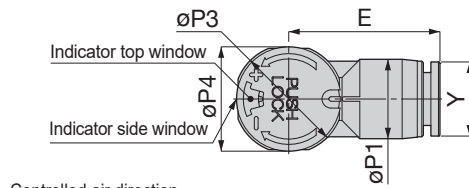

Taper pipe thread

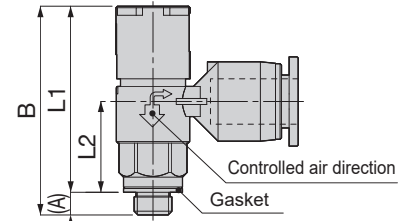

Unified thread type

Unit : mm

Model	Tubing O.D. øD	R	A	B		L1		L2	øP1	øP2	øP3	Tube end C	E	øP4	Hex. H	X	Y	Weight (g)					
				Unlock	Lock	Unlock	Lock																
JSGC1/8-U10 ^[4] 5 ^[5] W	1/8"	10-32UNF	3	27.6	26.7	24.6	23.7	12	8	9.7	10.4	11	17.3	9.8	8	9.8	7.8	6.5					
JSGC5/32-U10 ^[4] 5 ^[5] W	5/32"	10-32UNF	3	27.6	26.7	24.6	23.7	12	8	9.7	10.4	11	17.3	9.8	8	9.8	7.8	6.7					
JSGC5/32-N1 ^[4] 5 ^[5] W		1/8NPT	8	33.5	32.5	29.4	28.4	14.5										13.2	14.4	17.6	13.8	12	14
JSGC3/16-U10 ^[4] 5 ^[5] W	3/16"	10-32UNF	3	27.6	26.7	24.6	23.7	12	10.5	9.7	10.4	11.7	19.3	9.8	8	11.8	9.8	7.1					
JSGC3/16-N1 ^[4] 5 ^[5] W		1/8NPT	8	33.5	32.5	29.4	28.4	14.5										13.2	14.4	20.1	13.8	12	14
JSGC3/16-N2 ^[4] 5 ^[5] W		1/4NPT	11	39.8	38.8	34	33	17.7										16.8	14.4	22.1	—	17	26
JSGC3/16-N3 ^[4] 5 ^[5] W		3/8NPT	12	48.8	47.6	42.7	41.5	25.4										21	19.6	22.9	—	19	49
JSGC1/4-U10 ^[4] 5 ^[5] W	1/4"	10-32UNF	3	27.6	26.7	24.6	23.7	12	10.5	9.7	10.4	11.4	19.4	9.8	8	11.8	9.8	6.9					
JSGC1/4-N1 ^[4] 5 ^[5] W		1/8NPT	8	33.5	32.5	29.4	28.4	14.5										13.2	14.4	20.2	13.8	12	14
JSGC1/4-N2 ^[4] 5 ^[5] W		1/4NPT	11	39.8	38.8	34	33	17.7										16.8	14.4	22.2	—	17	26
JSGC1/4-N3 ^[4] 5 ^[5] W		3/8NPT	12	48.8	47.6	42.7	41.5	25.4										21	19.6	23	—	19	48
JSGC5/16-N1 ^[4] 5 ^[5] W	5/16"	1/8NPT	8	33.5	32.5	29.4	28.4	16.7	14.5	13.2	14.4	18.1	30.5	13.8	12	13.8	—	18					
JSGC5/16-N2 ^[4] 5 ^[5] W		1/4NPT	11	39.8	38.8	34	33	17.7										16.8	14.4	30.2	—	17	29
JSGC5/16-N3 ^[4] 5 ^[5] W		3/8NPT	12	48.8	47.6	42.7	41.5	25.4										21	19.6	31.4	—	19	51
JSGC5/16-N4 ^[4] 5 ^[5] W		1/2NPT	15	54	52.8	45.9	44.7	27										26	19.6	33.1	—	24	78
JSGC3/8-N2 ^[4] 5 ^[5] W	3/8"	1/4NPT	11	39.8	38.8	34	33	17.7	17.5	16.8	14.4	20.2	32.1	13.8	17	16.8	—	32					
JSGC3/8-N3 ^[4] 5 ^[5] W		3/8NPT	12	48.8	47.6	42.7	41.5	25.4										21	19.6	33	—	19	55
JSGC3/8-N4 ^[4] 5 ^[5] W		1/2NPT	15	54	52.8	45.9	44.7	27										26	19.6	35.7	—	24	81
JSGC1/2-N3 ^[4] 5 ^[5] W	1/2"	3/8NPT	12	48.8	47.6	42.7	41.5	25.4	21	21	19.6	23.7	37.5	—	19	19.8	—	58					
JSGC1/2-N4 ^[4] 5 ^[5] W		1/2NPT	15	54	52.8	45.9	44.7	27										26	19.6	39.8	—	24	84

※) Specify the flow direction in [4], the flow rate type in [5] of the model code referring to the model designation example mentioned above.

Dimensions - BSPT & Metric thread

JSGC Elbow



Meter-out control
(Exhaust control)



Meter-out control
(Air supply control)

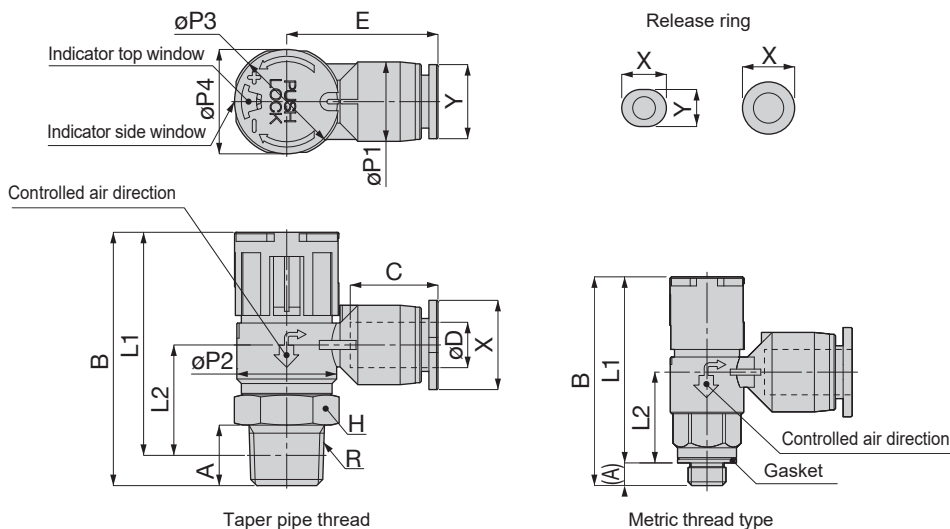

Unit : mm

Model	Tubing O.D. ϕD	R	A	B		L1		L2	$\phi P1$	$\phi P2$	$\phi P3$	Tube end C	E	$\phi P4$	Hex. H	X	Y	Weight (g)
				Unlock	Lock	Unlock	Lock											
JSGC3-M3 ⁴ W ⁵	3	M3×0.5	2.5	27.6	26.7	25.1	24.2	12.5	8	9.7	10.4	11	17.3	9.8	8	9.8	7.8	6.5
JSGC3-M5 ⁴ W ⁵		M5×0.8	3			24.6	23.7											12
JSGC4-M3 ⁴ W ⁵	4	M3×0.5	2.5	27.6	26.7	25.1	24.2	12.5	8	9.7	10.4	11	17.3	9.8	8	9.8	7.8	6.6
JSGC4-M5 ⁴ W ⁵		M5×0.8	3			24.6	23.7											12
JSGC4-01 ⁴ W ⁵	4	R1/8	8	33.5	32.5	29.5	28.5	14.6	8	13.2	14.4	11	17.6	13.8	12	9.8	7.8	14
JSGC6-M5 ⁴ W ⁵		M5×0.8	3	27.6	26.7	24.6	23.7	12		10.5	9.7		10.4	11.6	19.2			9.8
JSGC6-01 ⁴ W ⁵	R1/8	8	33.5	32.5	29.5	28.5	14.6	13.2	14.4		20	12	14					
JSGC6-02 ⁴ W ⁵	R1/4	11	39.8	38.8	33.8	32.8	17.5	16.8	14.4	22	13.8	17	25					
JSGC6-03 ⁴ W ⁵	R3/8	11	48.8	47.6	42.5	41.3	25.2	21	19.6	22.8	—	19	48					
JSGC8-01 ⁴ W ⁵	8	R1/8	8	33.5	32.5	29.5	28.5	16.8	14.5	13.2	14.4	18.1	30.5	13.8	12	13.8	—	17
JSGC8-02 ⁴ W ⁵		R1/4	11	39.8	38.8	33.8	32.8	17.5		16.8	14.4		30.2	17	28			
JSGC8-03 ⁴ W ⁵		R3/8	12	48.8	47.6	42.5	41.3	25.2		21	19.6		31.4	—	19			51
JSGC8-04 ⁴ W ⁵		R1/2	15	54	52.8	45.8	44.6	26.9		26	19.6		33.1	—	24			78
JSGC10-02 ⁴ W ⁵	10	R1/4	11	39.8	38.8	33.8	32.8	17.5	17.5	16.8	14.4	20.2	32.1	13.8	17	16.8	—	31
JSGC10-03 ⁴ W ⁵		R3/8	12	48.8	47.6	42.5	41.3	25.2		21	19.6		33	—	19			54
JSGC10-04 ⁴ W ⁵		R1/2	15	54	52.8	45.8	44.6	26.9		26	19.6		35.7	—	24			81
JSGC12-03 ⁴ W ⁵	12	R3/8	12	48.8	47.6	42.5	41.3	25.2	21	21	19.6	23.4	37.2	—	19	19.8	—	58
JSGC12-04 ⁴ W ⁵		R1/2	15	54	52.8	45.8	44.6	26.9		26	19.6		39.5	—	24			85
JSGC1/8-M3 ⁴ W ⁵	1/8"	M3×0.5	2.5	27.6	26.7	25.1	24.2	12.5	8	9.7	10.4	11	17.3	9.8	8	9.8	7.8	6.5
JSGC1/8-M5 ⁴ W ⁵		M5×0.8	3			24.6	23.7	12										6.5
JSGC5/32-M3 ⁴ W ⁵	5/32"	M3×0.5	2.5	27.6	26.7	25.1	24.2	12.5	8	9.7	10.4	11	17.3	9.8	8	9.8	7.8	6.6
JSGC5/32-M5 ⁴ W ⁵		M5×0.8	3			24.6	23.7	12										6.7
JSGC5/32-01 ⁴ W ⁵	5/32"	R1/8	8	33.5	32.5	29.5	28.5	14.6	8	13.2	14.4	11	17.6	13.8	12	9.8	7.8	14
JSGC1/4-M5 ⁴ W ⁵		M5×0.8	3	27.6	26.7	24.6	23.7	12		9.7	10.4		19.4	9.8	8			6.9
JSGC1/4-01 ⁴ W ⁵	1/4"	R1/8	8	33.5	32.5	29.5	28.5	14.6	10.5	13.2	14.4	11.4	20.2	13.8	12	11.8	9.8	14
JSGC1/4-02 ⁴ W ⁵		R1/4	11	39.8	38.8	33.8	32.8	17.5		16.8	14.4		22.2	17	25			
JSGC1/4-03 ⁴ W ⁵		R3/8	12	48.8	47.6	42.5	41.3	25.2		21	19.6		23	—	19			48
JSGC5/16-01 ⁴ W ⁵	5/16"	R1/8	8	33.5	32.5	29.5	28.5	16.8	14.5	13.2	14.4	18.1	30.5	13.8	12	13.8	—	17
JSGC5/16-02 ⁴ W ⁵		R1/4	11	39.8	38.8	33.8	32.8	17.5		16.8	14.4		30.2	17	28			
JSGC5/16-03 ⁴ W ⁵		R3/8	12	48.8	47.6	42.5	41.3	25.2		21	19.6		31.4	—	19			51
JSGC5/16-04 ⁴ W ⁵		R1/2	15	54	52.8	45.8	44.6	26.9		26	19.6		33.1	—	24			78
JSGC3/8-02 ⁴ W ⁵	3/8"	R1/4	11	39.8	38.8	33.8	32.8	17.5	17.5	16.8	14.4	20.2	32.1	13.8	17	16.8	—	32
JSGC3/8-03 ⁴ W ⁵		R3/8	12	48.8	47.6	42.5	41.3	25.2		21	19.6		33	—	19			54
JSGC3/8-04 ⁴ W ⁵		R1/2	15	54	52.8	45.8	44.6	26.9		26	19.6		35.7	—	24			81
JSGC1/2-03 ⁴ W ⁵	1/2"	R3/8	12	48.8	47.6	42.5	41.3	25.2	21	21	19.6	23.7	37.5	—	19	19.8	—	57
JSGC1/2-04 ⁴ W ⁵		R1/2	15	54	52.8	45.8	44.6	26.9		26	19.6		39.8	—	24			85

※) Specify the flow direction in ⁴, the flow rate type in ⁵ of the model code referring to the model designation example mentioned above.

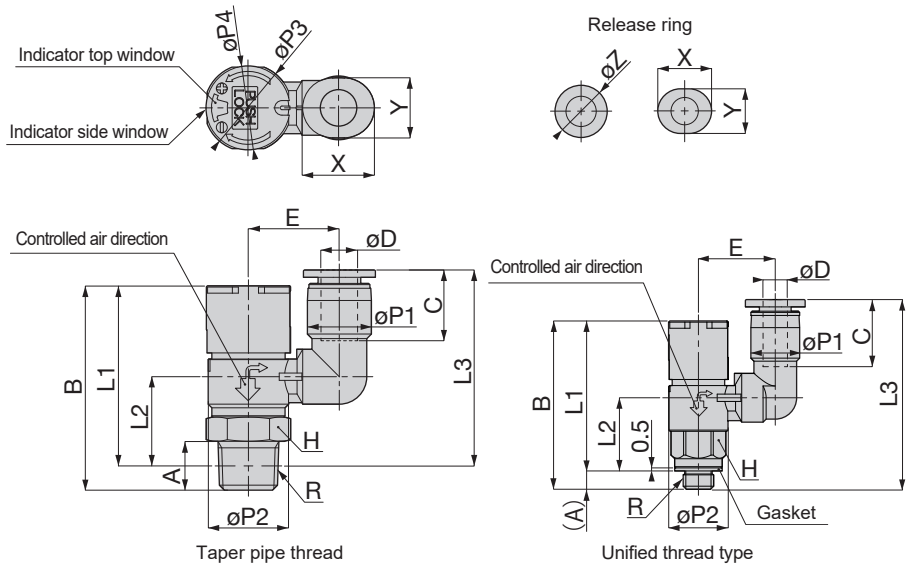

▪ NPT and Unified thread

Unit : mm

Model	Tubing øD	R	A	B		L1		L2	L3	øP1	øP2	øP3	øP4	Tube End C	E	Hex H	Release ring			Wt. (g)
				Unlock	Lock	Unlock	Lock										øZ	X	Y	
JSGS1/8-U10[4][5]W	1/8"	10-32UNF	3	27.6	26.7	24.6	23.7	12	28.1	8	9.7	10.4	9.8	11	12.6	8	—	9.8	7.8	6.9
JSGS5/32-U10[4][5]W	5/32"	10-32UNF	3	27.6	26.7	24.6	23.7	12	29.7	10.5	9.7	10.4	9.8	11.4	14.1	12	—	9.8	7.8	7.1
JSGS5/32-N1[4][5]W		1/8NPT	8	33.5	32.5	29.4	28.4	14.5	30.6		13.2	14.4	13.8		13.4	8				15
JSGS1/4-U10[4][5]W	1/4"	10-32UNF	3	27.6	26.7	24.6	23.7	12	29.7	10.5	9.7	10.4	9.8	11.4	14.9	12	—	11.8	9.8	7.5
JSGS1/4-N1[4][5]W		1/8NPT	8	33.5	32.5	29.4	28.4	14.5	32.2		13.2	14.4	13.8		15	17				26
JSGS1/4-N2[4][5]W	1/4NPT	11	39.8	38.8	34	33	18.2	35.9	14.5	18.4	14.4	13.8	18.1	19.1	12	13.8	—	—	19	
JSGS5/16-N1[4][5]W	1/8NPT	8	33.5	32.5	29.4	28.4	15.3	41		13.2				19.6	—				22.1	19
JSGS5/16-N2[4][5]W	1/4NPT	11	39.8	38.8	34	33	18.2	43.9		18.4	—	—		22.1	19				54	
JSGS5/16-N3[4][5]W	3/8NPT	12	48.8	47.6	42.7	41.5	24.8	52.5	21	19.6	—	—	22.1	19	54	—	—	—	54	
JSGS3/8-N2[4][5]W	3/8"	1/4NPT	11	39.8	38.8	34	33	18.2	47	17.5	18.4	14.4	13.8	20.2	19.3	17	16.8	—	—	30
JSGS3/8-N3[4][5]W		3/8NPT	12	48.8	47.6	42.7	41.5	24.8	54.8		21	19.6	—		22.6	19				53
JSGS3/8-N4[4][5]W		1/2NPT	15	54	52.8	45.9	44.7	27	57		26	—	—		25.7	24				81
JSGS1/2-N3[4][5]W	1/2"	3/8NPT	12	48.8	47.6	42.7	41.5	24.8	58.8	21	21	19.6	—	23.7	23.1	19	19.8	—	—	60
JSGS1/2-N4[4][5]W		1/2NPT	15	54	52.8	45.9	44.7	27	62.5		26	—	—		25.7	24				87

▪ BSPT and metric thread

Model	Tubing øD	R	A	B		L1		L2	L3	øP1	øP2	øP3	øP4	Tube End C	E	Hex H	Release ring			Wt. (g)		
				Unlock	Lock	Unlock	Lock										øZ	X	Y			
JSGS3-M3[4][5]W	3	M3x0.5	2.5	27.6	26.7	25.1	24.2	12.5	28.6	8	9.7	10.4	9.8	11	12.6	8	—	9.8	7.8	6.9		
JSGS3-M5[4][5]W		M5x0.8	3			24.6	23.7	12	28.1													
JSGS4-M3[4][5]W	4	M3x0.5	2.5	27.6	26.7	25.1	24.2	12.5	28.6	8	9.7	10.4	9.8	11	12.6	8	—	9.8	7.8	7.1		
JSGS4-M5[4][5]W		M5x0.8	3			24.6	23.7	12	28.1													
JSGS4-01[4][5]W	R1/8	8	33.5	32.5	29.5	28.5	14.6	30.7	10.5	13.2	14.4	13.8	11.6	14.1	12	—	11.8	9.8	14			
JSGS6-M5[4][5]W	M5x0.8	3	27.6	26.7	24.6	23.7	12	29.5		9.7	10.4	9.8		13.4	8				7.6			
JSGS6-01[4][5]W	6	R1/8	8	33.5	32.5	29.5	28.5	14.6	32.1	10.5	13.2	14.4	13.8	11.6	14.9	12	—	11.8	9.8	15		
JSGS6-02[4][5]W		R1/4	11	39.8	38.8	33.8	32.8	18	35.5		18.4				15	17				26		
JSGS8-01[4][5]W	8	R1/8	8	33.5	32.5	29.5	28.5	15.4	41.1	14.5	13.2	14.4	13.8	18.1	19.1	12	13.8	—	—	18		
JSGS8-02[4][5]W		R1/4	11	39.8	38.8	33.8	32.8	18	43.7		18.4				17	13.8				—	—	30
JSGS8-03[4][5]W		R3/8	12	48.8	47.6	42.5	41.3	24.6	52.3		21				19.6	—				22.1	19	53
JSGS10-02[4][5]W	10	R1/4	11	39.8	38.8	33.8	32.8	18	47	17.5	18.4	14.4	13.8	20.2	19.3	17	16.8	—	—	29		
JSGS10-03[4][5]W		R3/8	12	48.8	47.6	42.5	41.3	24.6	54.6		21	19.6	—		22.6	19				53		
JSGS12-03[4][5]W	12	R3/8	12	48.8	47.6	42.5	41.3	24.6	58.3	21	21	19.6	—	23.4	23.1	19	19.8	—	—	60		
JSGS12-04[4][5]W		R1/2	15	54	52.8	45.8	44.6	26.9	62.1		26				—	—				25.7	24	87
JSGS1/8-M3[4][5]W	1/8"	M3x0.5	2.5	27.6	26.7	25.1	24.2	12.5	28.6	8	9.7	10.4	9.8	11	12.6	8	—	9.8	7.8	6.9		
JSGS1/8-M5[4][5]W		M5x0.8	3			24.6	23.7	12	28.1													
JSGS1/4-M5[4][5]W	1/4"	M5x0.8	3	27.6	26.7	24.6	23.7	12	29.7	10.5	9.7	10.4	9.8	11.4	13.4	8	—	11.8	9.8	7.5		
JSGS1/4-01[4][5]W		R1/8	8	33.5	32.5	29.5	28.5	14.6	32.3		13.2	14.4	13.8		14.9	12				15		
JSGS1/4-02[4][5]W	R1/4	11	39.8	38.8	33.8	32.8	18	35.7	18.4	14.4	13.8	15	17	26								
JSGS5/16-01[4][5]W	5/16"	R1/8	8	33.5	32.5	29.5	28.5	15.4	41.1	14.5	13.2	14.4	13.8	18.1	19.1	12	13.8	—	—	18		
JSGS5/16-02[4][5]W		R1/4	11	39.8	38.8	33.8	32.8	18	43.7		18.4				17	13.8				—	—	30
JSGS5/16-03[4][5]W		R3/8	12	48.8	47.6	42.5	41.3	24.6	52.3		21	19.6	—		22.1	19				53		
JSGS3/8-02[4][5]W	3/8"	R1/4	11	39.8	38.8	33.8	32.8	18	47	17.5	18.4	14.4	13.8	20.2	19.3	17	16.8	—	—	29		
JSGS3/8-03[4][5]W		R3/8	12	48.8	47.6	42.5	41.3	24.6	54.6		21	19.6	—		22.6	19				53		
JSGS3/8-04[4][5]W		R1/2	15	54	52.8	45.8	44.6	26.9	56.9		26	—	—		25.7	24				81		
JSGS1/2-03[4][5]W	1/2"	R3/8	12	48.8	47.6	42.5	41.3	24.6	58.6	21	21	19.6	—	23.7	23.1	19	19.8	—	—	59		
JSGS1/2-04[4][5]W		R1/2	15	54	52.8	45.8	44.6	26.9	62.4		26				—	—				25.7	24	87

※) Specify the flow direction in [4], the flow rate type in [5] of the model code referring to the model designation example mentioned above.

In Line Straight (JSGU) Flow Characteristics

JSGU5/32LW JSGU4LW

Controlled flow

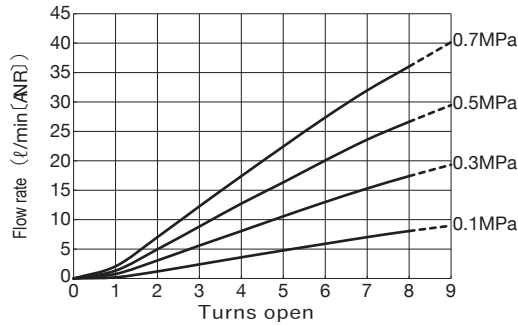

JSGU5/32W JSGU4W

Controlled flow

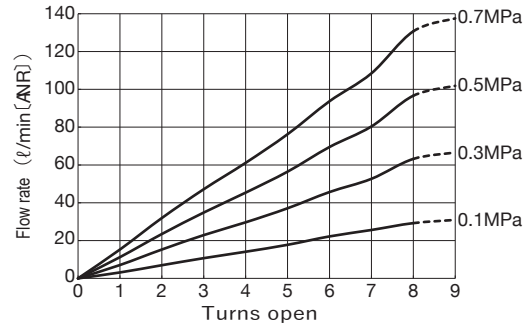

JSGU5/32(L)W JSGU4(L)W

Free flow

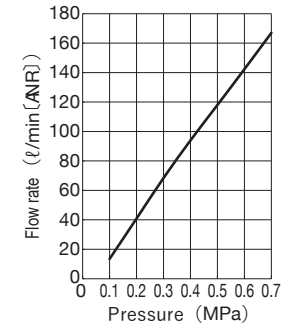

JSGU1/4LW

Controlled flow

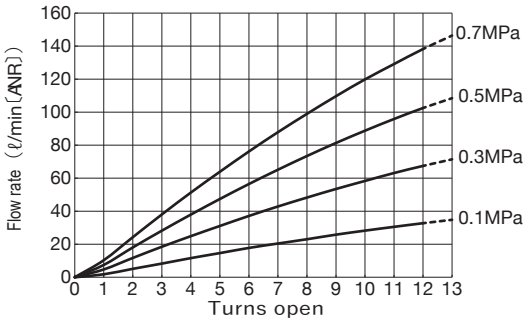

JSGU1/4W

Controlled flow

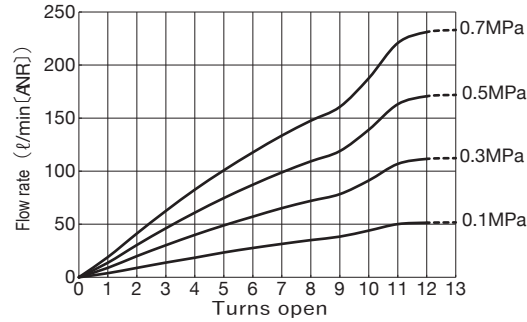

JSGU1/4(L)W

Free flow

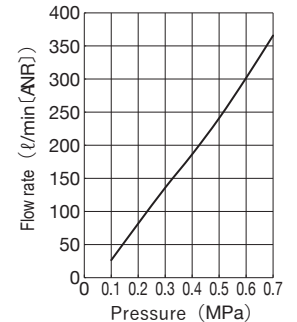

JSGU3/8LW

Controlled flow

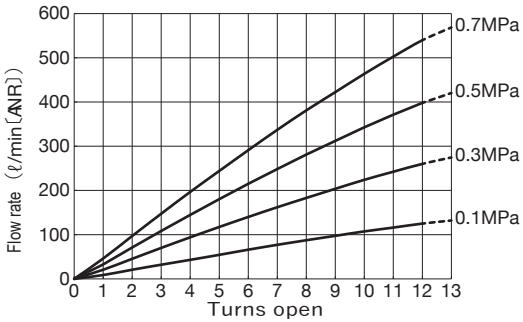

JSGU3/8W

Controlled flow

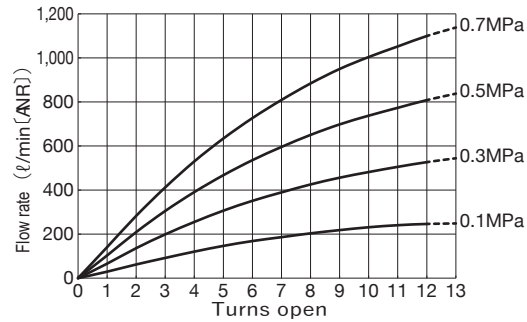

JSGU3/8(L)W

Free flow

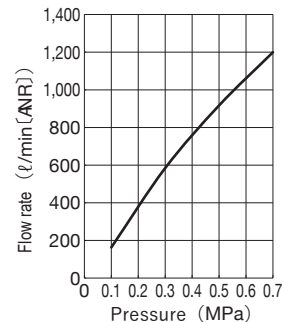

JSGU1/2LW

Controlled flow

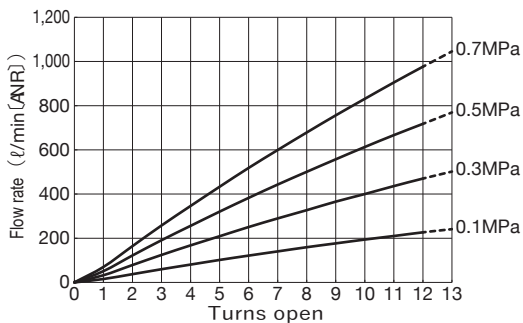

JSGU1/2W

Controlled flow

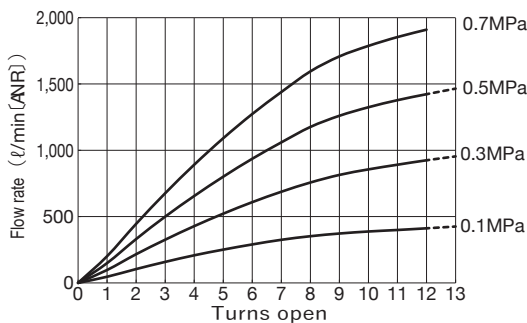

JSGU1/2(L)W

Free flow

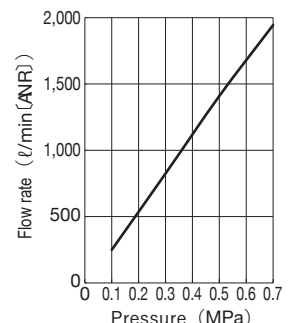

JSGU6LW

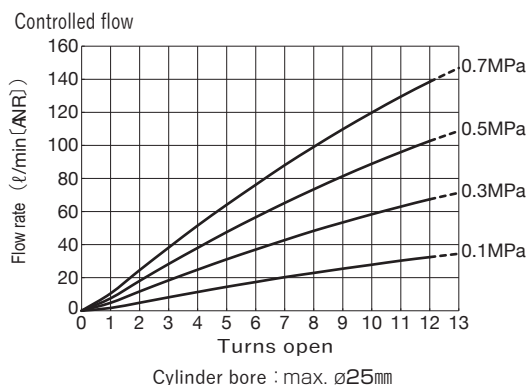

JSGU6W

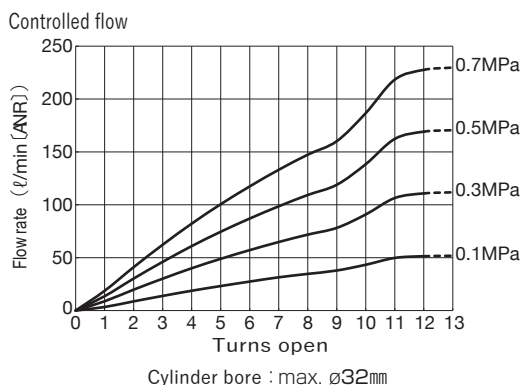

JSGU6(L)W

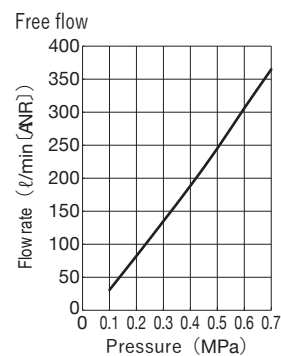

JSGU5/16LW
JSGU8LW

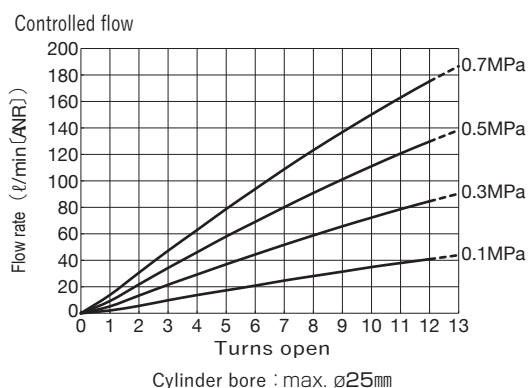

JSGU5/16W
JSGU8W

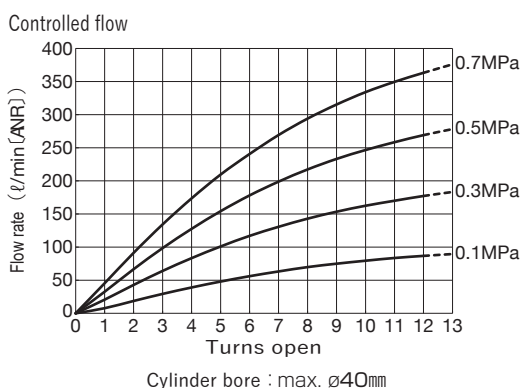

JSGU5/16(L)W
JSGU8(L)W

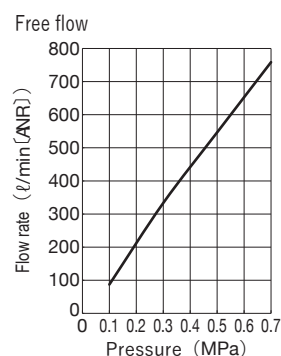

JSGU10LW

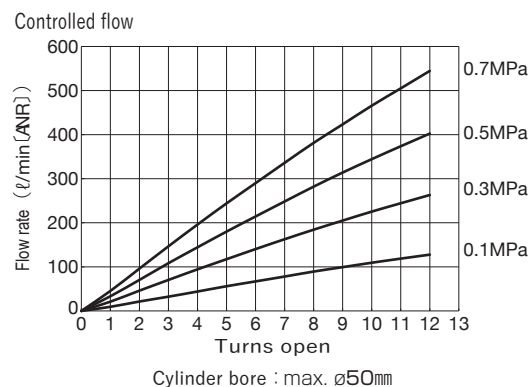

JSGU10W

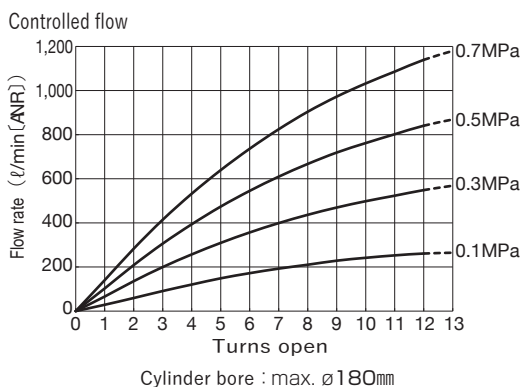

JSGU10(L)W

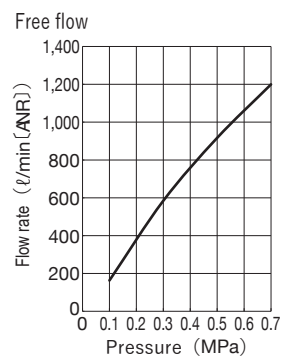

JSGU12LW

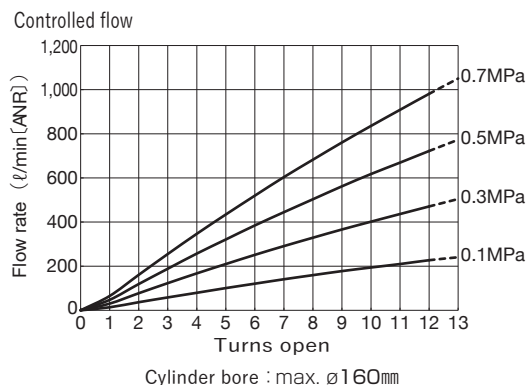

JSGU12W

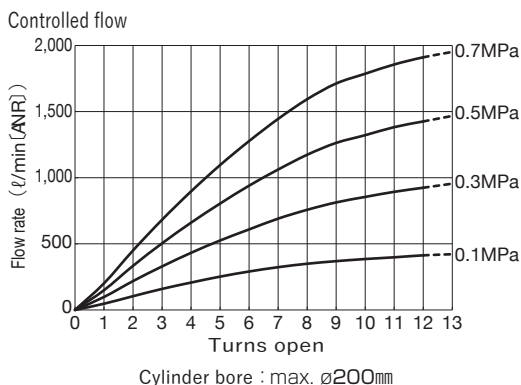

JSGU12(L)W

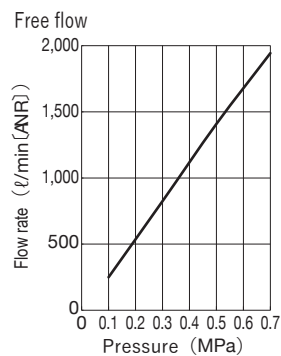

※) The flow characteristic can differ depending on the tolerance of the products and actuators, temperature and so on.

Push-Lock type Flow control valve with Indicator

Elbow type (JSGC) Flow Characteristics

JSG□1/8-M3□LW
JSG□3-M3□LW

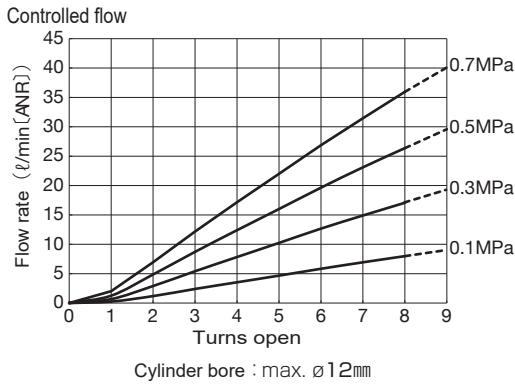

JSG□1/8-M3□W
JSG□3-M3□W

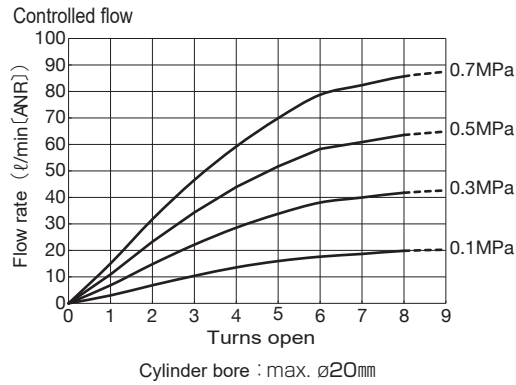

JSG□1/8-M3□(L)W
JSG□3-M3□(L)W

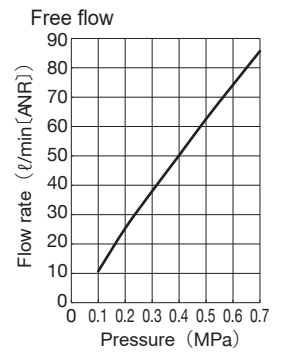

JSG□1/8-U10□LW JSG□3-M5□LW
JSG□1/8-M5□LW

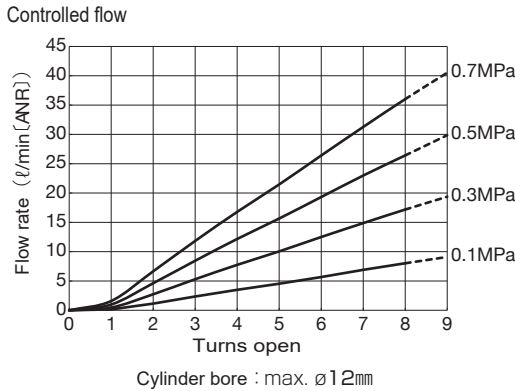

JSG□1/8-U10□W JSG□3-M5□W
JSG□1/8-M5□W

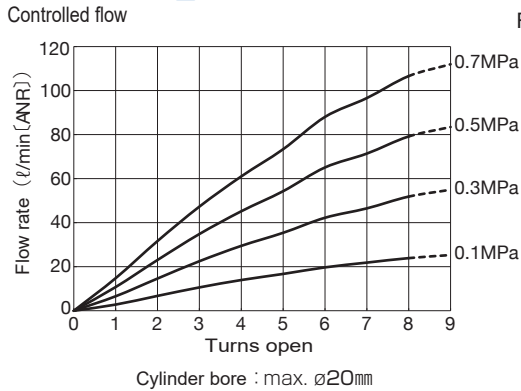

JSG□1/8-U10□(L)W
JSG□1/8-M5□(L)W

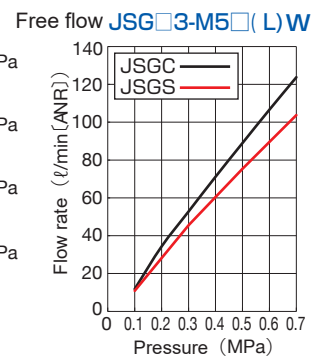

JSG□4-M3□LW
JSGC5/32-M3□LW

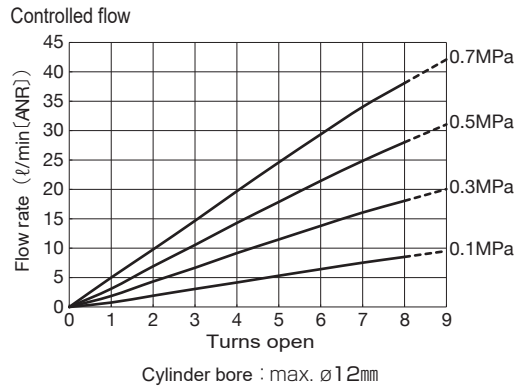

JSG□4-M3□W
JSGC5/32-M3□W

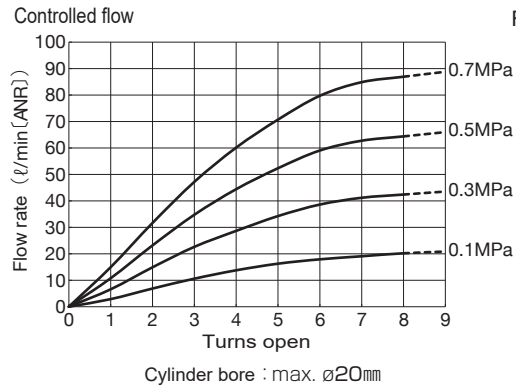

JSG□4-M3□(L)W
JSGC5/32-M3□(L)W

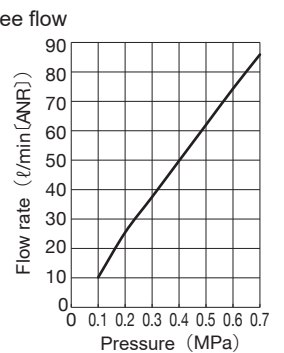

JSG□5/32-U10□LW JSG□4-M5□LW
JSGC5/32-M5□LW

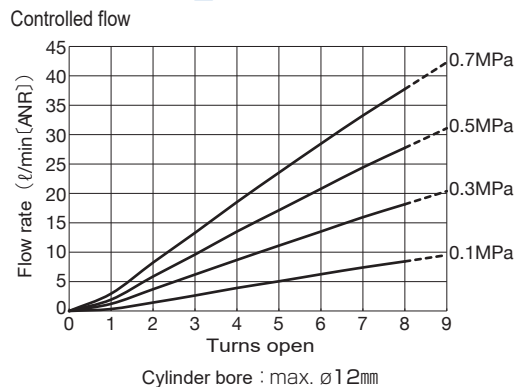

JSG□5/32-U10□W JSG□4-M5□W
JSGC5/32-M5□W

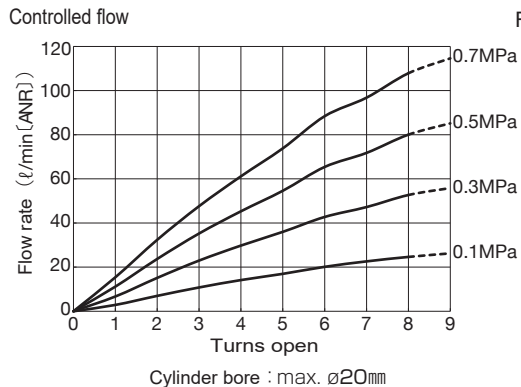

JSG□5/32-U10□(L)W
JSGC5/32-M5□(L)W

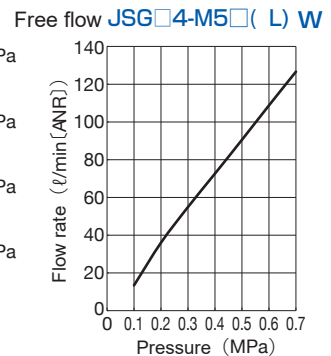

※) The flow characteristic can differ depending on the tolerance of the products and actuators, temperature and so on.

JSG□5/32-N1□LW JSG□4-01□LW
JSGC5/32-01□LW

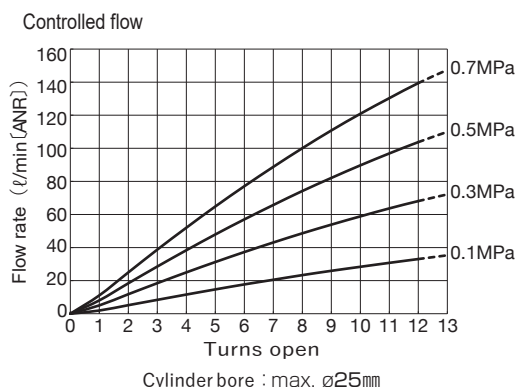

JSG□5/32-N1□W JSG□4-01□W
JSGC5/32-01□W

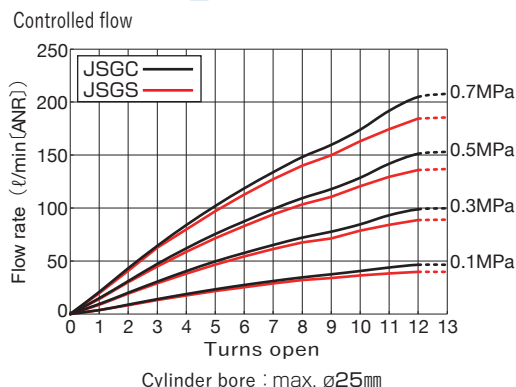

JSG□5/32-N1□(L)W
JSGC5/32-01□(L)W
JSG□4-01□(L)W

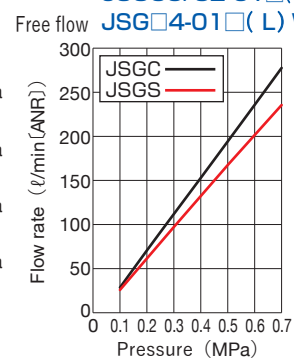

JSG□1/4-U10□LW
JSG□1/4-M5□LW

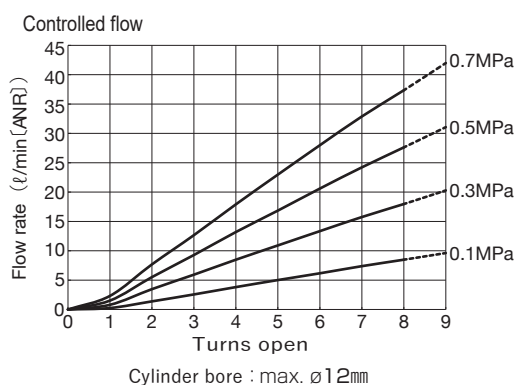

JSG□1/4-U10□W
JSG□1/4-M5□W

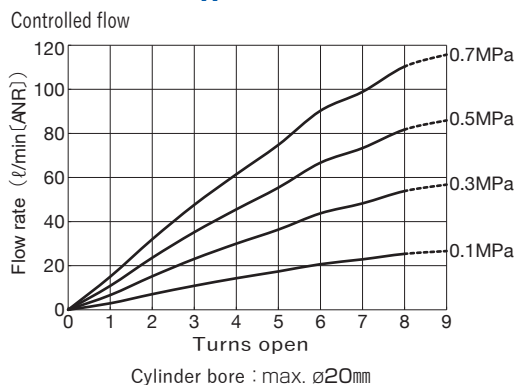

JSG□1/4-U10□(L)W
JSG□1/4-M5□(L)W

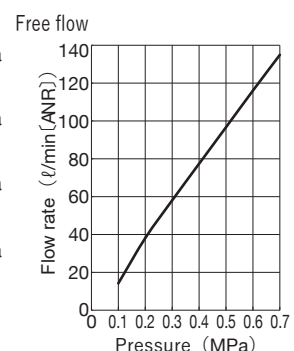

JSG□1/4-N1□LW
JSG□1/4-01□LW

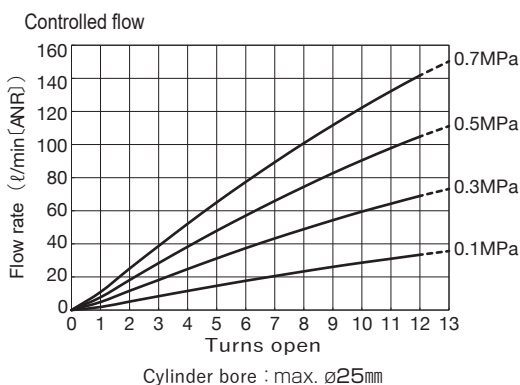

JSG□1/4-N1□W
JSG□1/4-01□W

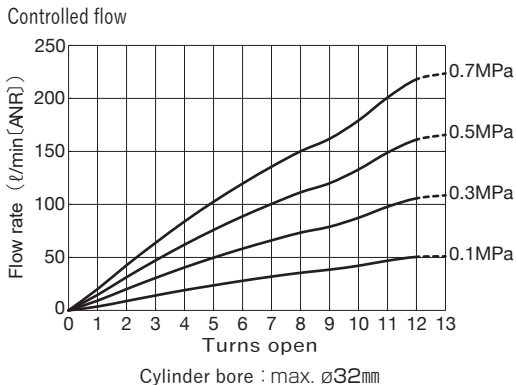

JSG□1/4-N1□(L)W
JSG□1/4-01□(L)W

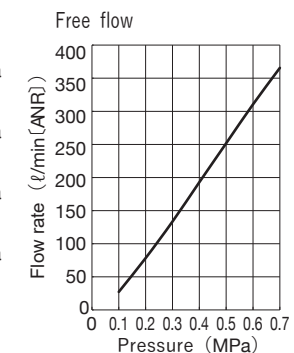

JSG□1/4-N2□LW
JSG□1/4-02□LW

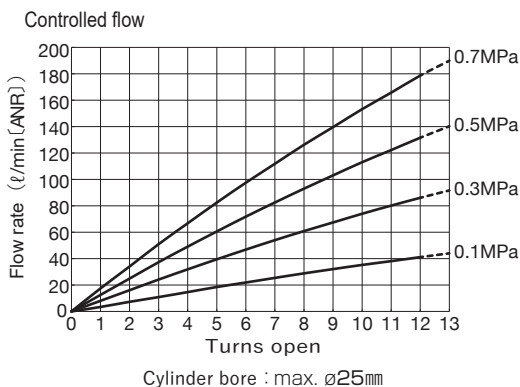

JSG□1/4-N2□W
JSG□1/4-02□W

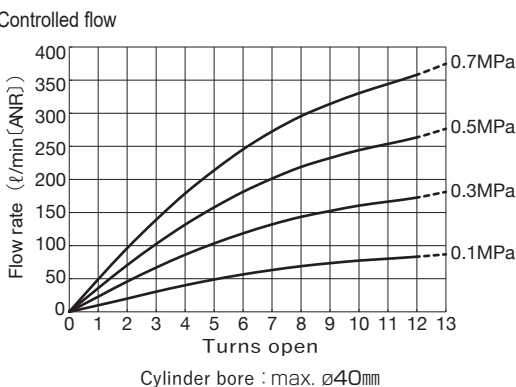

JSG□1/4-N2□(L)W
JSG□1/4-02□(L)W

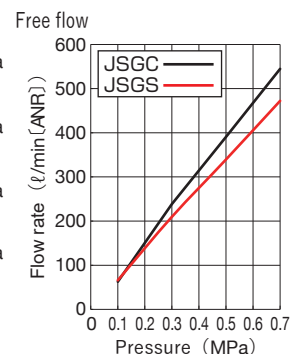

Push-Lock type Flow control valve with Indicator

JSGC 1/4-N3□LW JSGC 1/4-O3□LW

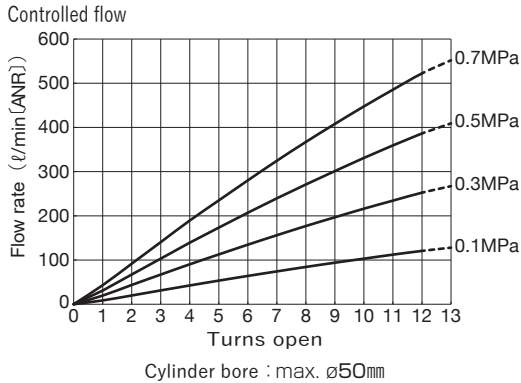

JSGC 1/4-N3□W JSGC 1/4-O3□W

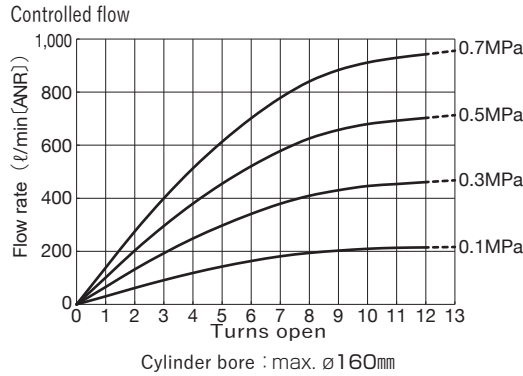

JSGC 1/4-N3□(L)W JSGC 1/4-O3□(L)W

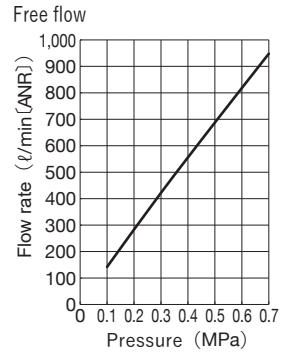

JSG□3/8-N2□LW JSG□3/8-O2□LW

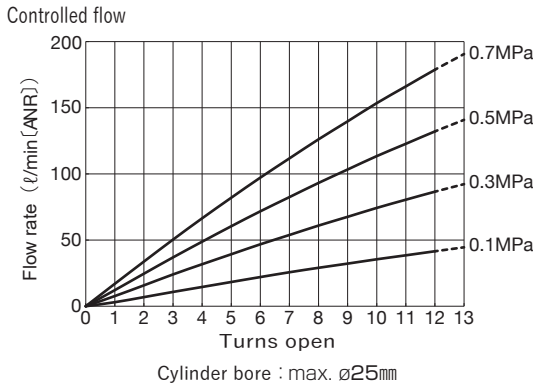

JSG□3/8-N2□W JSG□3/8-O2□W

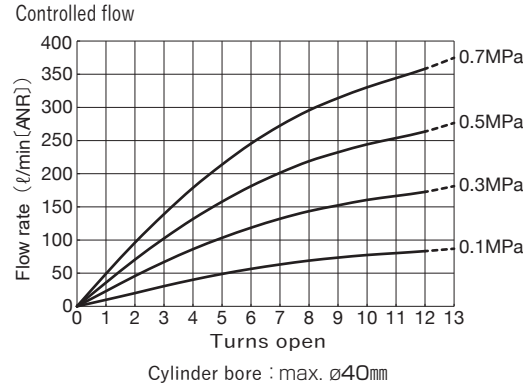

JSG□3/8-N2□(L)W JSG□3/8-O2□(L)W

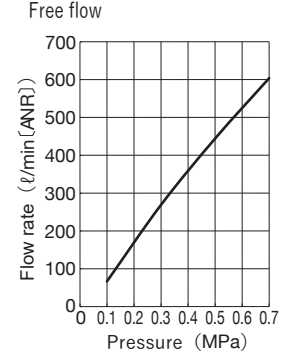

JSG□3/8-N3□LW JSG□3/8-O3□LW

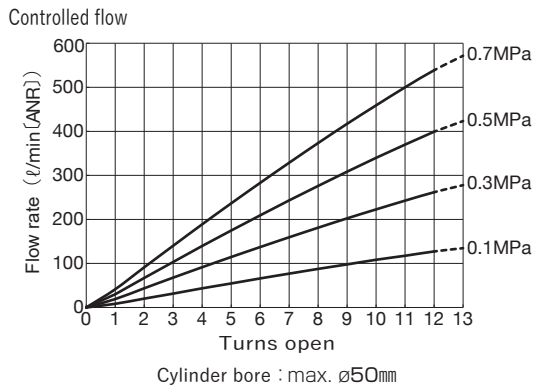

JSG□3/8-N3□W JSG□3/8-O3□W

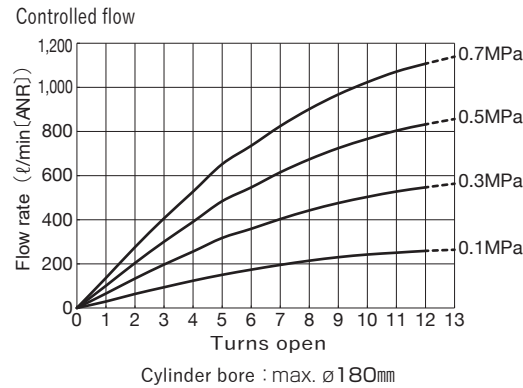

JSG□3/8-N3□(L)W JSG□3/8-O3□(L)W

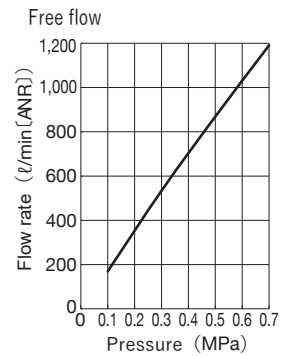

JSG□3/8-N4□LW JSG□3/8-O4□LW

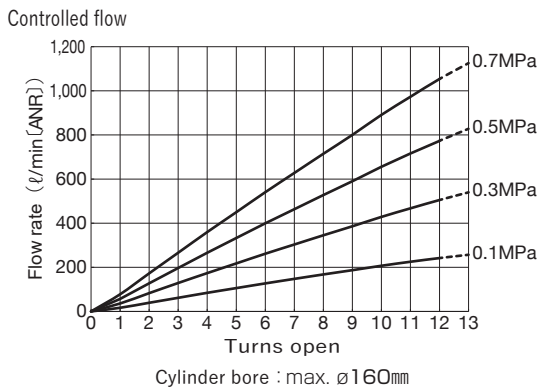

JSG□3/8-N4□W JSG□3/8-O4□W

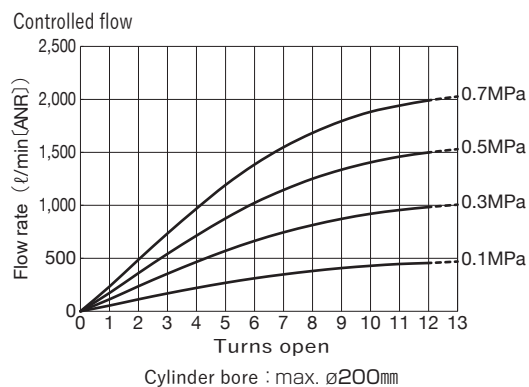

JSG□3/8-N4□(L)W JSG□3/8-O4□(L)W

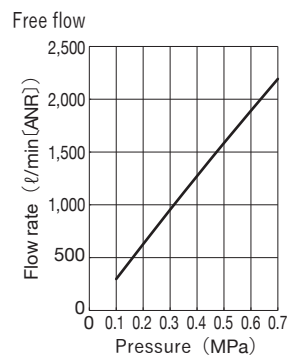

JSG□1/2-N3□LW
JSG□1/2-O3□LW

Controlled flow

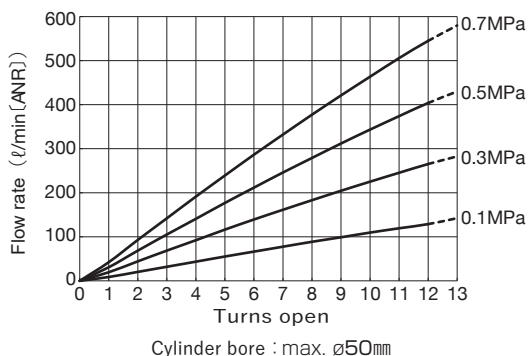

JSG□1/2-N3□W
JSG□1/2-O3□W

Controlled flow

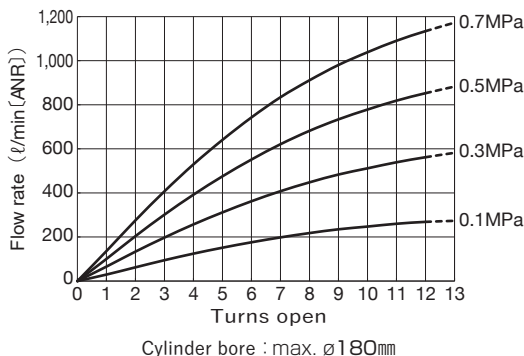

JSG□1/2-N3□(L)W
JSG□1/2-O3□(L)W

Free flow

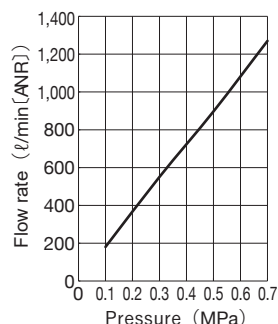

JSG□1/2-N4□LW
JSG□1/2-O4□LW

Controlled flow

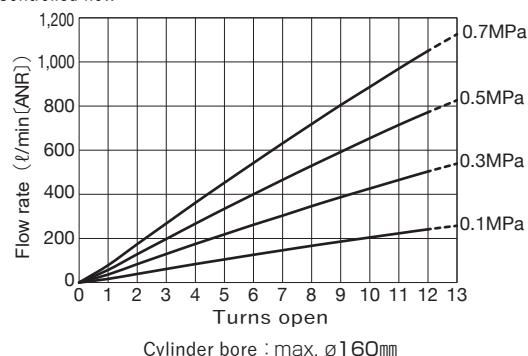

JSG□1/2-N4□W
JSG□1/2-O4□W

Controlled flow

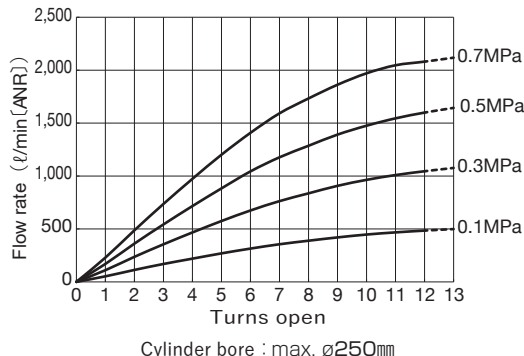

JSG□1/2-N4□(L)W
JSG□1/2-O4□(L)W

Free flow

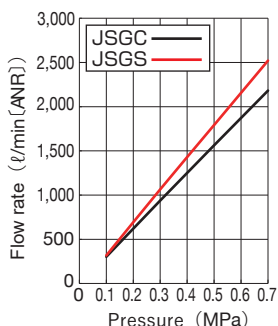

JSGC3/16-U10□LW
JSG□6-M5□LW

Controlled flow

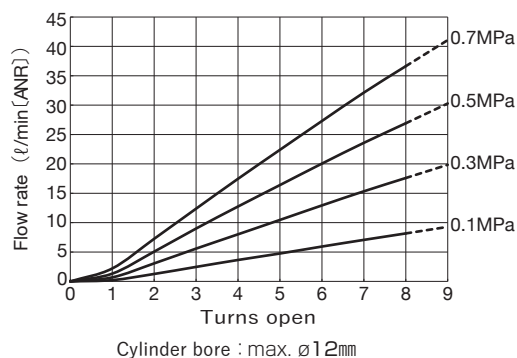

JSGC3/16-U10□W
JSG□6-M5□W

Controlled flow

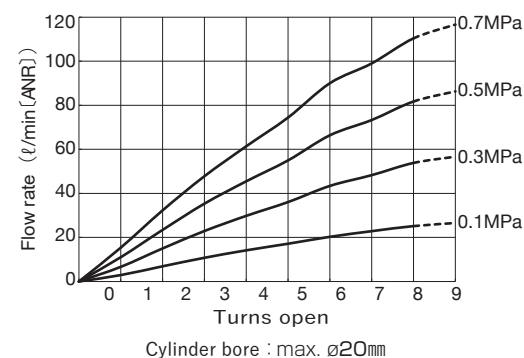

JSGC3/16-U10□(L)W
JSG□6-M5□(L)W

Free flow

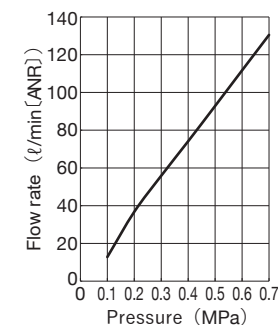

JSGC3/16-N1□LW
JSG□6-O1□LW

Controlled flow

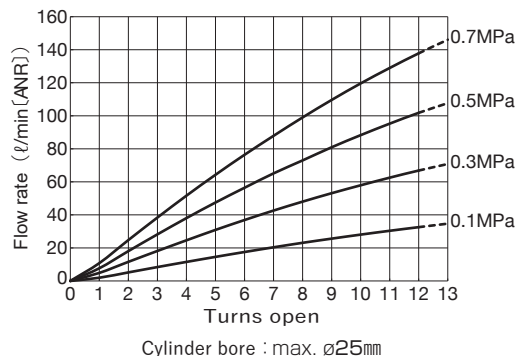

JSGC3/16-N1□W
JSG□6-O1□W

Controlled flow

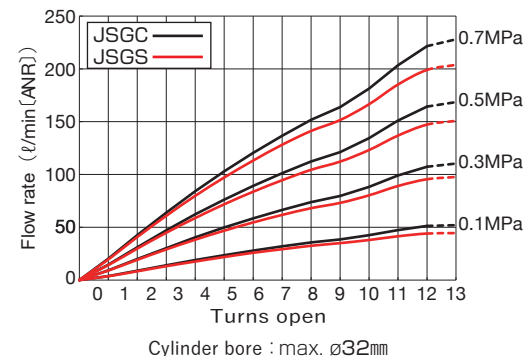

JSGC3/16-N1□(L)W
JSG□6-O1□(L)W

Free flow

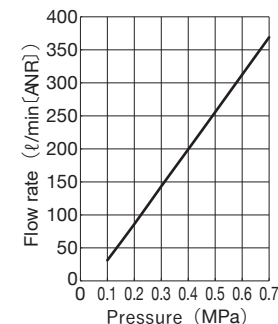

Push-Lock type Flow control valve with Indicator

JSGC3/16-N2□LW
JSG□6-02□L W

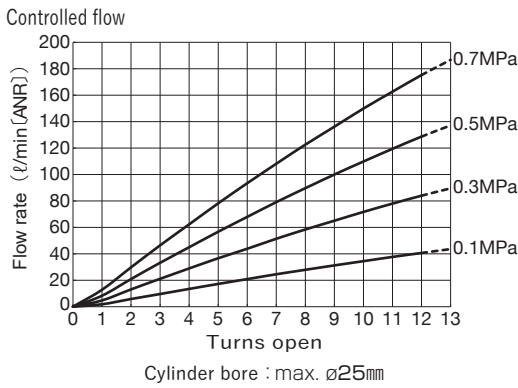

JSGC3/16-N2□W
JSG□6-02□W

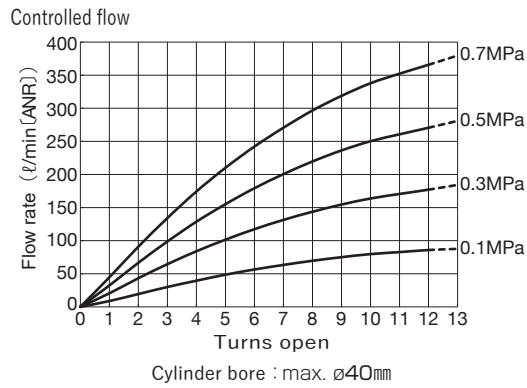

JSGC3/16-N2□(L)W
JSG□6-02□(L)W

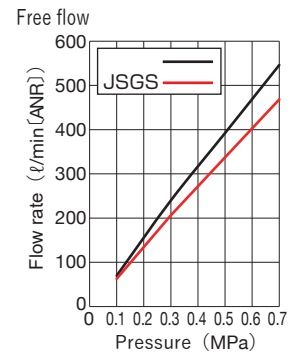

JSGC3/16-N3□LW
JSG□6-03□L W

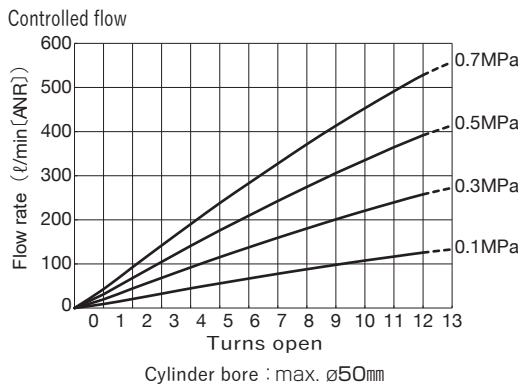

JSGC3/16-N3□W
JSG□6-03□ W

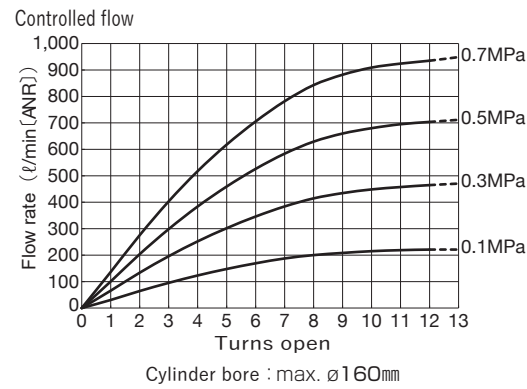

JSGC3/16-N3□(L)W
JSG□6-03□(L)W

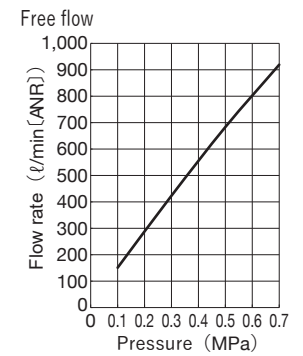

JSG□5/16-N1□LW **JSG□8-01□LW**
JSG□5/16-01□LW

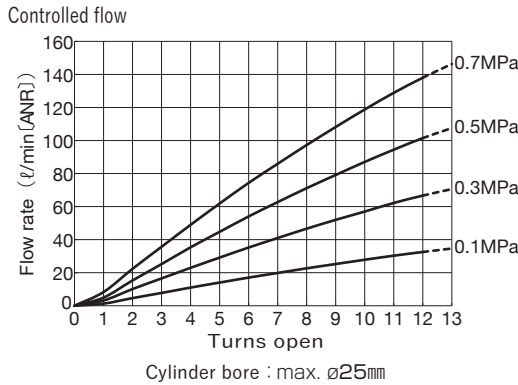

JSG□5/16-N1□W **JSG□8-01□W**
JSG□5/16-01□W

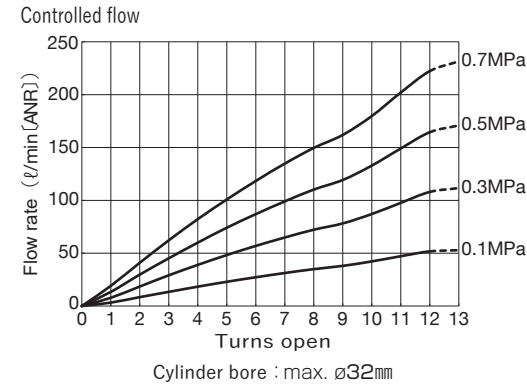

JSG□5/16-N1□(L)W
JSG□5/16-01□(L)W
JSG□8-01□(L)W

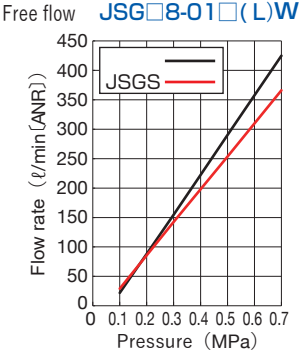

JSG□5/16-N2□LW **JSG□8-02□LW**
JSG□5/16-02□LW

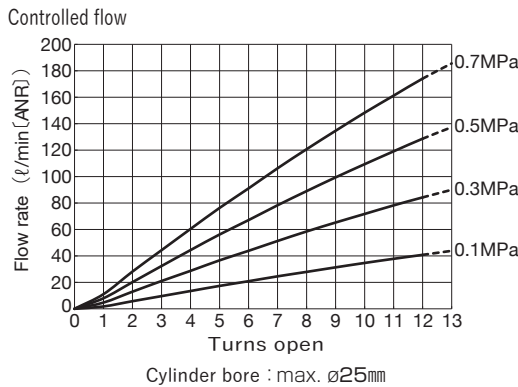

JSG□5/16-N2□W **JSG□8-02□W**
JSG□5/16-02□W

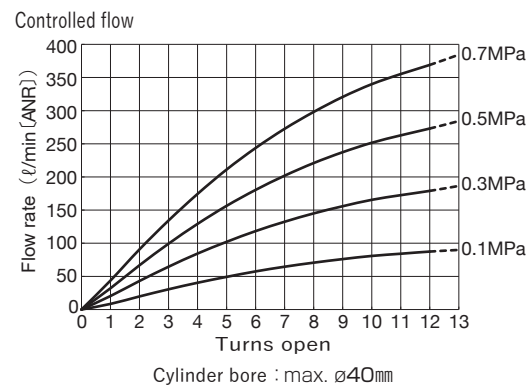

JSG□5/16-N2□(L)W
JSG□5/16-02□(L)W
JSG□8-02□(L)W

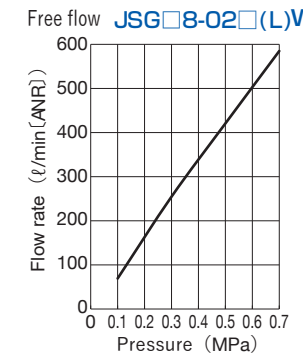

JSG□5/16-N3□LW JSG□8-03□LW
JSG□5/16-03□LW

Controlled flow

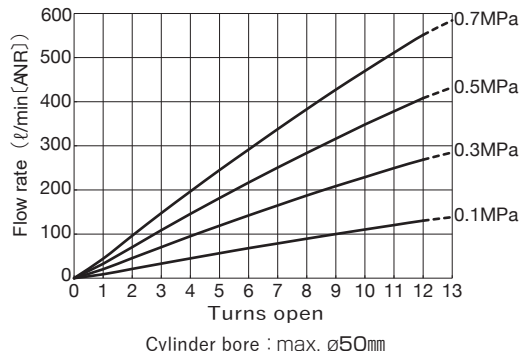

JSG□5/16-N3□W JSG□8-03□W
JSG□5/16-03□W

Controlled flow

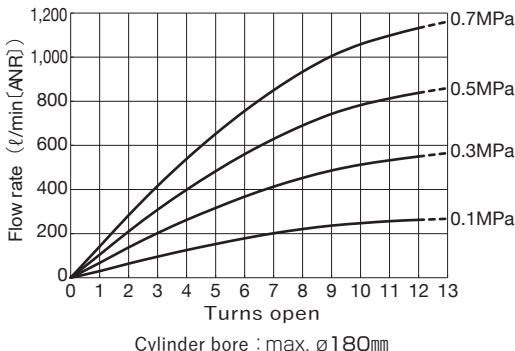

JSG□5/16-N3□(L)W
JSG□5/16-03□(L)W
Free flow JSG□8-03□(L)W

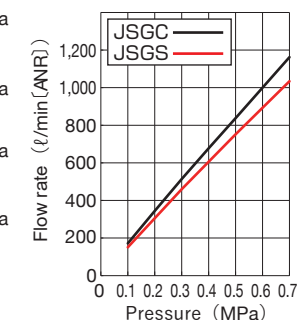

JSGC5/16-N4□LW JSGC8-04□LW
JSGC5/16-04□LW

Controlled flow

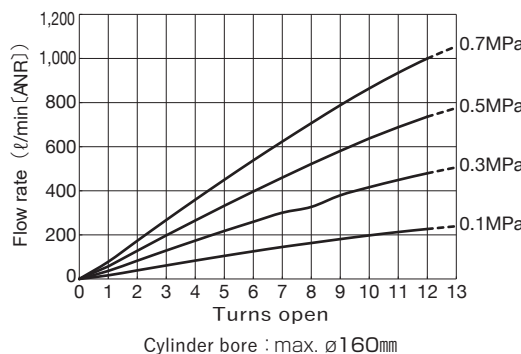

JSGC5/16-N4□W JSGC8-04□W
JSGC5/16-04□W

Controlled flow

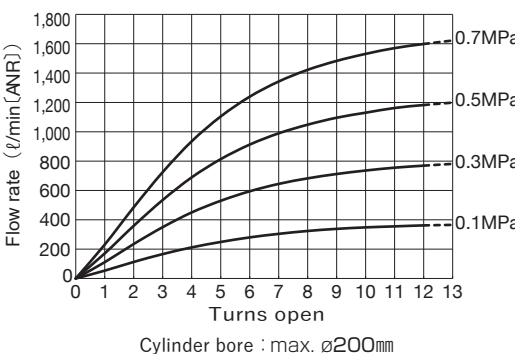

JSGC5/16-N4□(L)W
JSGC5/16-04□(L)W
Free flow JSGC8-04□(L)W

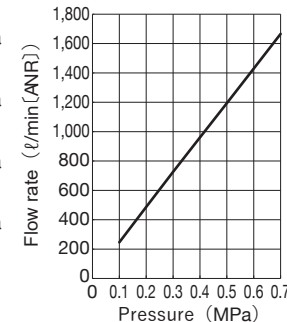

JSG□10-02□LW

Controlled flow

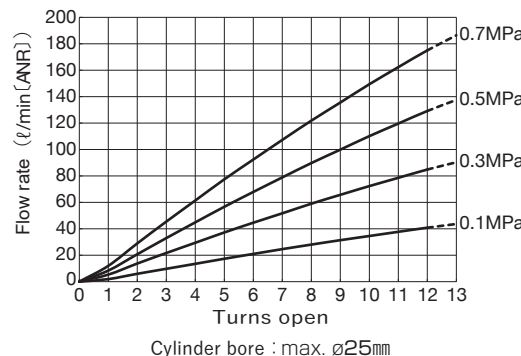

JSG□10-02□W

Controlled flow

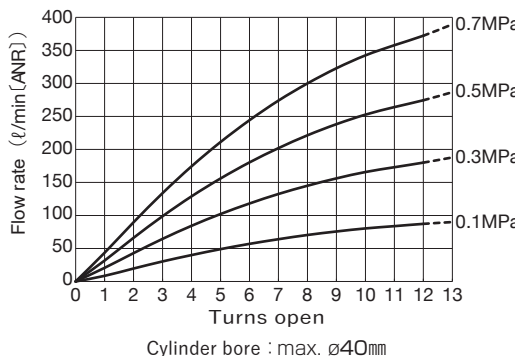

JSG□10-02□(L)W

Free flow

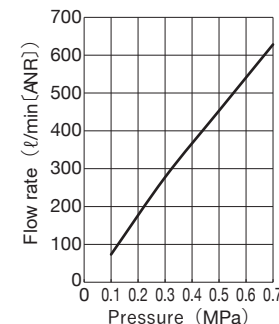

JSG□10-03□LW

Controlled flow

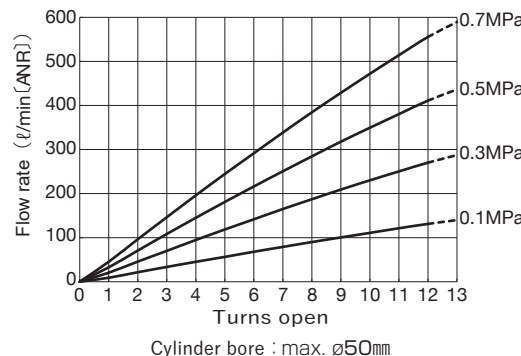

JSG□10-03□W

Controlled flow

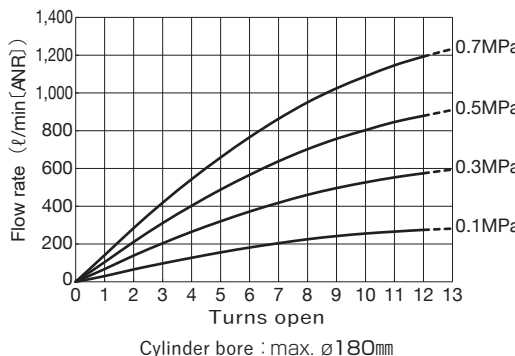

JSG□10-03□(L)W

Free flow

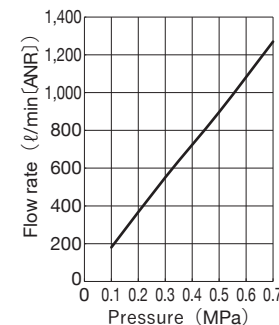

Push-Lock type Flow control valve with Indicator

JSGC10-04□LW

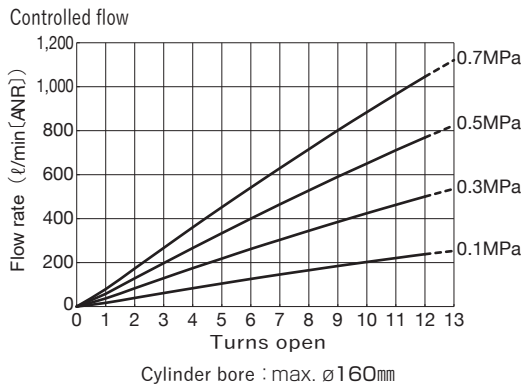

JSGC10-04□W

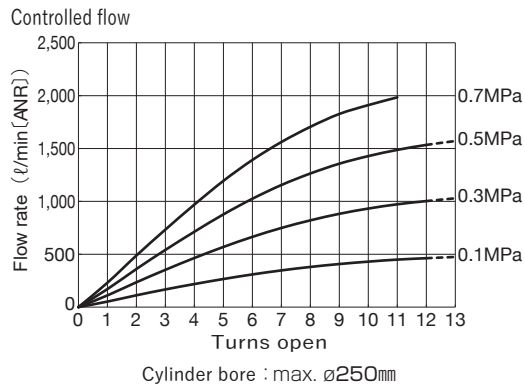

JSGC10-04□(L)W

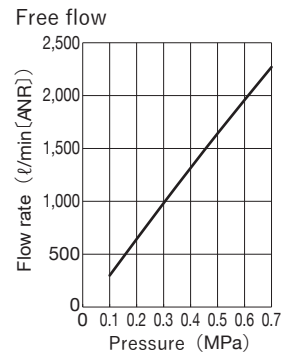

JSG□12-03□LW

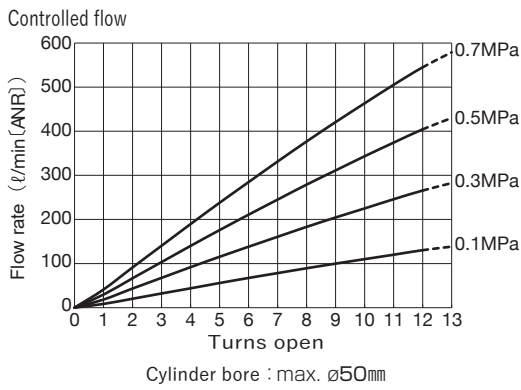

JSG□12-03□W

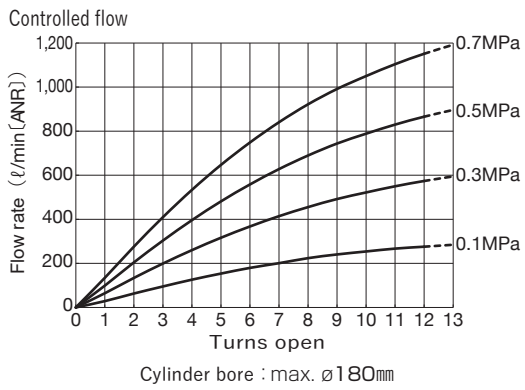

JSG□12-03□(L)W

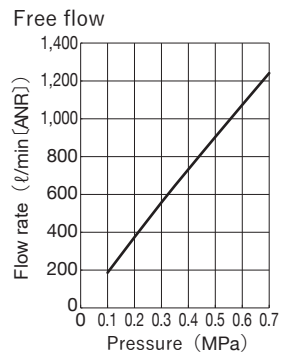

JSG□12-04□LW

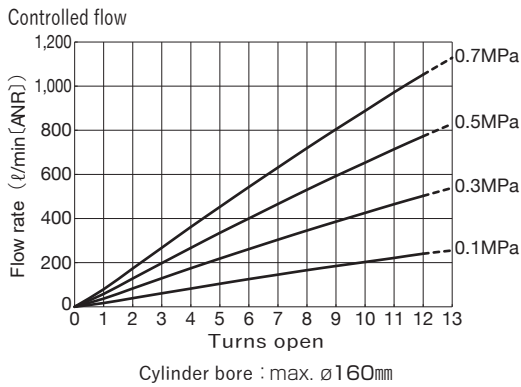

JSG□12-04□W

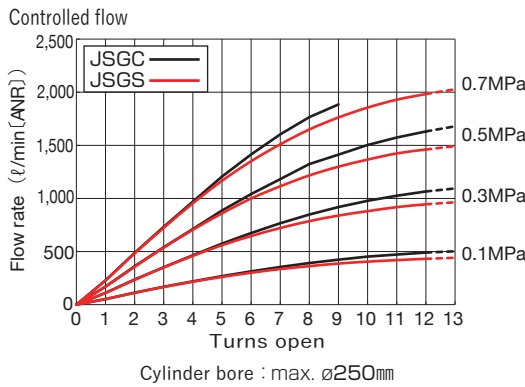

JSG□12-04□(L)W

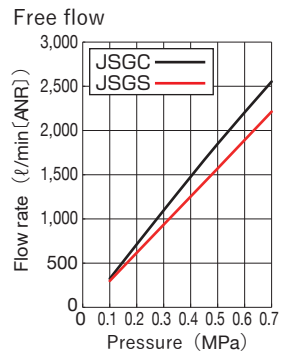

※) The flow characteristic can differ depending on the tolerance of the products and actuators, temperature and so on.