

Push-In Fitting for High Speed Swiveling Application Rotary Joint

Package: 1 pc. in a bag

- Rotary Joint with a bearing incorporated is suitable for swiveling and rotating applications.

Model Designation(Example)

RC 1/4 - N1 U
① ② ③ ④

①Type: C - Swiveling Straight or L - Swiveling Elbow

②Tube Dia.(φD)

	mm size				
Code	4	6	8	10	12
Size.	φ4mm	φ6mm	φ8mm	φ10mm	φ12mm
	in. size				
Code	5/32	3/16	1/4	5/16	3/8
Size.	φ5/32	φ3/16	φ1/4	φ5/16	φ3/8

③Thread size -NPT, UNF, metric or R (BSPT)

	Unified fine thread		American standard taper pipe thread		
Code	U10		N1	N2	N3
Size	10-32UNF		NPT1/8	NPT1/4	NPT3/8
	Metric thread		BSPT - Taper pipe thread		
Code	M5	M6	01	02	03
Size	M5×0.8	M6×1.0	R1/8	R1/4	R3/8

④U:Hexagon flat-to-flat inch spec. (UNF,NPT)

No Code:Hexagon flat-to-flat metric spec. (M,R)

Specifications

Fluid admitted	Air,Vacuum	
Service pressure range	0~150psi	0~0.9MPa(0~9.9kgf/cm ²)
Working vacuum	-29.5in.Hg	-750mmHg(10Torr)
Service temperature range	32~140°F	0~60°C

Notes: ·Use the rotary joint with air only. Never use them with water or other liquids, or with gases other than air.

Construction

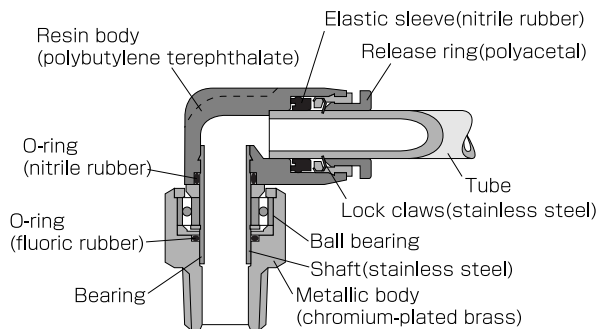

⚠ Caution

- Avoid radial load. It may shorten the lifetime.
- Use polyurethane tubing for the high rotation applications. Stiff tubing like a nylon may cause such radial load.

*The gasket material of M and UNF thread is SUS304 + NBR

Allowable No. of revolutions of Rotary Joint

Tube dia.	φ5/32, φ4	φ3/16, φ1/4, φ6	φ5/16, φ8	φ3/8, φ10	φ1/2, φ12
r.p.m	500 min ⁻¹	500 min ⁻¹	400 min ⁻¹	300 min ⁻¹	250 min ⁻¹

※ . min⁻¹ : rotation per minute

RC

Straight

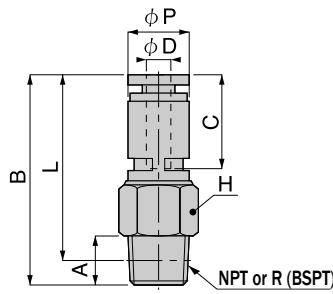

Unit : inch

Model	Tube dia. φD	NPT	A	B	L	φP	C	H	Allowable Revolutions	Idling torque under g·cm	Weight (OZ)	Orifice φMM	Eff.a. mm2	CV
RC 5/32-U10U	5/32	10-32UNF	0.14	1.30	1.16	0.41	0.59	1/2	500	60	0.46	1.80	1.90	0.10
RC 5/32-N1U	5/32	1/8	0.31	1.36	1.20	0.51	0.59	1/2	500	60	0.52	2.50	3.60	0.20
RC 3/16-N1U	3/16	1/8	0.31	1.46	1.30	0.51	0.67	9/16	500	120	0.63	4.00	7.10	0.38
RC 3/16-N2U	3/16	1/4	0.43	1.54	1.30	0.51	0.67	9/16	500	120	0.81	4.00	6.30	0.34
RC 1/4-N1U	1/4	1/8	0.31	1.46	1.30	0.51	0.67	9/16	500	120	0.64	4.00	9.00	0.49
RC 1/4-N2U	1/4	1/4	0.43	1.54	1.30	0.51	0.67	9/16	500	120	0.82	4.00	9.00	0.49
RC 5/16-N1U	5/16	1/8	0.31	1.81	1.65	0.59	0.71	11/16	400	150	1.19	6.00	20.00	1.08
RC 5/16-N2U	5/16	1/4	0.43	1.77	1.54	0.59	0.71	11/16	400	150	1.13	6.00	20.00	1.08
RC 5/16-N3U	5/16	3/8	0.47	1.77	1.52	0.59	0.71	11/16	400	150	1.38	6.00	20.00	1.08
RC 3/8-N3U	3/8	3/8	0.47	2.22	1.97	0.71	0.79	7/8	300	200	2.48	8.00	37.80	2.05
RC 3/8-N4U	3/8	1/2	0.59	2.32	2.01	0.71	0.79	7/8	300	200	3.01	8.00	36.30	1.97
RC 1/2-N3U	1/2	3/8	0.47	2.46	2.20	0.83	0.93	1	250	250	3.56	9.50	50.00	2.71
RC 1/2-N4U	1/2	1/2	0.59	2.46	2.13	0.83	0.93	1	250	250	3.70	9.50	50.00	2.71

Unit : inch

Model	Tube dia. φD(mm)	R	A	B	L	φP	C	H	※1 r.p.m	※2g-cm less than	Weight (OZ)	Orifice φMM	Eff.a. mm2	CV
RC 4-M5	4	M5	0.14	1.30	1.16	0.41	0.59	0.47	500	60	0.42	1.80	1.90	0.10
RC 4-M6	4	M6	0.18	1.34	1.16	0.41	0.59	0.47	500	60	0.46	2.50	4.20	0.23
RC 4-01	4	R1/8	0.31	1.36	1.20	0.41	0.59	0.47	500	60	0.49	2.50	3.60	0.20
RC 6-M6	6	M6	0.18	1.48	1.30	0.51	0.67	0.55	500	120	0.65	3.00	4.50	0.24
RC 6-01	6	R1/8	0.31	1.46	1.30	0.51	0.67	0.55	500	120	0.60	4.00	9.00	0.49
RC 6-02	6	R1/4	0.43	1.54	1.30	0.51	0.67	0.55	500	120	0.81	4.00	9.00	0.49
RC 8-01	8	R1/8	0.31	1.81	1.65	0.59	0.71	0.67	400	150	1.13	6.00	20.00	1.08
RC 8-02	8	R1/4	0.43	1.77	1.54	0.59	0.71	0.67	400	150	1.09	6.00	20.00	1.08
RC 8-03	8	R3/8	0.47	1.77	1.52	0.59	0.71	0.67	400	150	1.34	6.00	20.00	1.08
RC 10-01	10	R1/8	0.31	2.20	2.05	0.71	0.79	0.87	300	200	2.38	7.00	35.00	1.90
RC 10-02	10	R1/4	0.43	2.32	2.09	0.71	0.79	0.94	300	200	2.97	7.00	35.00	1.90
RC 10-03	10	R3/8	0.47	2.22	1.97	0.71	0.79	0.87	300	200	2.29	8.00	35.00	1.90
RC 10-04	10	R1/2	0.59	2.32	2.01	0.71	0.79	0.87	300	200	2.85	8.00	35.00	1.90
RC 12-02	12	R1/4	0.43	2.44	2.18	0.83	0.92	0.94	250	250	3.27	7.00	50.00	2.71
RC 12-03	12	R3/8	0.47	2.46	2.20	0.83	0.92	0.94	250	250	3.34	9.50	50.00	2.71
RC 12-04	12	R1/2	0.59	2.46	2.15	0.83	0.92	0.94	250	250	3.56	9.50	50.00	2.71
RC 1/4-01	1/4	R1/8	0.31	1.54	1.38	0.51	0.67	0.55	500	120	0.60	4.00	9.00	0.49
RC 1/4-02	1/4	R1/4	0.43	1.61	1.38	0.51	0.67	0.55	500	120	0.81	4.00	9.00	0.49
RC 5/16-01	5/16	R1/8	0.31	1.81	1.65	0.59	0.71	0.67	400	150	1.13	6.00	20.00	1.08
RC 5/16-02	5/16	R1/4	0.43	1.77	1.54	0.59	0.71	0.67	400	150	1.09	6.00	20.00	1.08
RC 5/16-03	5/16	R3/8	0.47	1.77	1.52	0.59	0.71	0.67	400	150	1.34	6.00	20.00	1.08
RC 3/8-03	3/8	R3/8	0.47	2.22	1.97	0.71	0.79	0.87	300	200	2.29	8.00	35.00	1.90
RC 3/8-04	3/8	R1/2	0.59	2.32	2.01	0.71	0.79	0.87	300	200	2.85	8.00	35.00	1.90

※1 Allowable revolutions ※2 Idling torque

❖ R stands for BSPT

RL Elbow

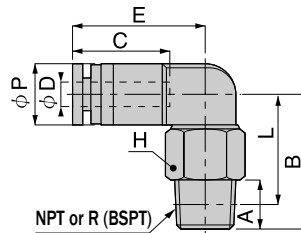

Unit : inch

Model	Tube dia. ϕ D	NPT	A	B	L	Φ P	C	E	H	Allowable Revolutions	Idling torque under g·cm	Weight (OZ)	Orifice ϕ MM	Eff.a. mm ²	CV
RL5/32-U10U	5/32	10-32UNF	0.14	0.81	0.67	0.41	0.59	0.79	1/2	500	60	0.49	1.80	1.50	0.08
RL5/32-N1U	5/32	1/8	0.31	0.87	0.71	0.41	0.59	0.79	1/2	500	60	0.54	2.50	2.90	0.16
RL3/16-N1U	3/16	1/8	0.31	0.94	0.79	0.51	0.67	0.91	9/16	500	120	0.67	4.00	5.80	0.31
RL3/16-N2U	3/16	1/4	0.43	1.02	0.79	0.51	0.67	0.91	9/16	500	120	0.84	4.00	6.30	0.34
RL1/4-N1U	1/4	1/8	0.31	0.94	0.79	0.51	0.67	0.91	9/16	500	120	0.65	4.00	7.50	0.41
RL1/4-N2U	1/4	1/4	0.43	1.02	0.79	0.51	0.67	0.91	9/16	500	120	0.83	4.00	7.50	0.41
RL5/16-N1U	5/16	1/8	0.31	1.24	1.08	0.59	0.71	1.02	11/16	400	150	1.24	6.00	16.50	0.89
RL5/16-N2U	5/16	1/4	0.43	1.20	0.96	0.59	0.71	1.02	11/16	400	150	1.18	6.00	16.50	0.89
RL5/16-N3U	5/16	3/8	0.47	1.20	0.94	0.59	0.71	1.02	11/16	400	150	1.42	6.00	16.50	0.89
RL3/8-N3U	3/8	3/8	0.47	1.42	1.16	0.71	0.79	1.18	7/8	300	200	2.23	8.00	27.20	1.47
RL3/8-N4U	3/8	1/2	0.59	1.52	1.20	0.71	0.79	1.18	7/8	300	200	2.77	8.00	26.90	1.46
RL1/2-N3U	1/2	3/8	0.47	1.65	1.40	0.85	0.93	1.30	1	250	250	3.22	9.50	42.50	2.30
RL1/2-N4U	1/2	1/2	0.59	1.65	1.34	0.85	0.93	1.30	1	250	250	3.37	9.50	42.50	2.30

❖ Ask for the price and the availability of **RL3/8-N2 (3/8 O.D. x 1/4NPT)**

Unit : inch

Model	Tube dia. ϕ D(mm)	R	A	B	L	Φ P	C	E	H	※1 r.p.m	※2g-cm less than	Weight (OZ)	Orifice ϕ MM	Eff.a. mm ²	CV
RL4-M5	4	M5	0.14	0.81	0.67	0.41	0.59	0.79	0.47	500	60	0.46	1.80	1.50	0.08
RL4-M6	4	M6	0.18	0.85	0.67	0.41	0.59	0.79	0.47	500	60	0.49	2.50	4.00	0.22
RL4-01	4	R1/8	0.31	0.87	0.71	0.41	0.59	0.79	0.47	500	60	0.53	2.50	2.90	0.16
RL6-M6	6	M6	0.18	0.96	0.79	0.51	0.67	0.91	0.55	500	120	0.69	3.00	6.10	0.33
RL6-01	6	R1/8	0.31	0.94	0.79	0.51	0.67	0.91	0.55	500	120	0.67	4.00	7.50	0.41
RL6-02	6	R1/4	0.43	1.02	0.79	0.51	0.67	0.91	0.55	500	120	0.81	4.00	7.50	0.41
RL8-01	8	R1/8	0.31	1.24	1.08	0.59	0.71	1.02	0.67	400	150	1.16	6.00	16.50	0.89
RL8-02	8	R1/4	0.43	1.20	0.96	0.59	0.71	1.02	0.67	400	150	1.13	6.00	16.50	0.89
RL8-03	8	R3/8	0.47	1.20	0.94	0.59	0.71	1.02	0.67	400	150	1.37	6.00	16.50	0.89
RL10-01	10	R1/8	0.31	1.38	1.22	0.71	0.79	1.18	0.87	300	200	2.15	7.00	22.00	1.19
RL10-02	10	R1/4	0.43	1.50	1.26	0.71	0.79	1.18	0.94	300	200	2.73	7.00	21.00	1.14
RL10-03	10	R3/8	0.47	1.42	1.16	0.71	0.79	1.18	0.87	300	200	1.97	8.00	30.00	1.63
RL10-04	10	R1/2	0.59	1.52	1.20	0.71	0.79	1.18	0.87	300	200	2.53	8.00	24.00	1.30
RL12-02	12	R1/4	0.43	1.61	1.38	0.85	0.92	1.28	0.94	250	250	2.92	7.00	42.50	2.30
RL12-03	12	R3/8	0.47	1.65	1.40	0.85	0.92	1.30	0.94	250	250	2.96	9.50	42.50	2.30
RL12-04	12	R1/2	0.59	1.65	1.34	0.85	0.92	1.30	0.94	250	250	3.17	9.50	42.50	2.30
RL1/4-01	1/4	R1/8	0.31	0.94	0.79	0.51	0.67	0.91	0.55	500	120	0.67	4.00	7.50	0.41
RL1/4-02	1/4	R1/4	0.43	1.02	0.79	0.51	0.67	0.91	0.55	500	120	0.81	4.00	7.50	0.41
RL5/16-01	5/16	R1/8	0.31	1.24	1.08	0.59	0.71	1.02	0.67	400	150	1.16	6.00	16.50	0.89
RL5/16-02	5/16	R1/4	0.43	1.20	0.96	0.59	0.71	1.02	0.67	400	150	1.13	6.00	16.50	0.89
RL5/16-03	5/16	R3/8	0.47	1.20	0.94	0.59	0.71	1.02	0.67	400	150	1.37	6.00	16.50	0.89
RL3/8-03	3/8	R3/8	0.47	1.42	1.16	0.71	0.79	1.18	0.87	300	200	1.97	8.00	30.00	1.63
RL3/8-04	3/8	R1/2	0.59	1.52	1.20	0.71	0.79	1.18	0.87	300	200	2.53	8.00	30.00	1.63

※1 Allowable revolutions ※2 Idling torque ※3 R thread is same as BSPT

■ Standard Size List

Connection: Thread \leftrightarrow Tube

Type	Thread size	Tube O.D. (Inch)					
		5/32"	3/16"	1/4"	5/16"	3/8"	1/2"
RC Straight	10-32UNF	●					
	1/8NPT	●	●	●	●		
	1/4NPT		●	●	●		
	3/8NPT				●	●	●
	1/2NPT					●	●

Type	Thread size	Tube O.D. (Inch)					
		5/32"	3/16"	1/4"	5/16"	3/8"	1/2"
RL Elbow	10-32UNF	●					
	1/8NPT	●	●	●	●		
	1/4NPT		●	●	●		
	3/8NPT				●	●	●
	1/2NPT					●	●

Type	Thread size	Tube O.D. (mm)							
		4	6	8	10	12	1/4"	5/16"	3/8"
RC Straight	M5×0.8	●	●						
	M6×1	●	●						
	R1/8	●	●	●	●		●	●	
	R1/4		●	●	●	●	●	●	●
	R3/8			●	●	●	●	●	●
	R1/2				●	●			●

Type	Thread size	Tube O.D. (mm)							
		4	6	8	10	12	1/4"	5/16"	3/8"
RL Elbow	M5×0.8	●	●						
	M6×1	●	●						
	R1/8	●	●	●	●		●	●	
	R1/4		●	●	●	●	●	●	●
	R3/8			●	●	●	●	●	●
	R1/2				●	●			●

■ Precautions for use

1. Caution

Avoid radial load, since Rotary Joint series is designed small and light with the ultra small ball bearing and a shaft holder. Polyurethane Tube is recommended for the high rotation applications.

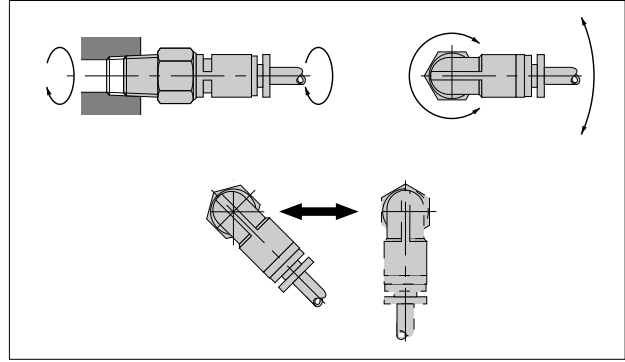

2. Combination example

3D movements can be achieved by the combination use of straight and elbow types.

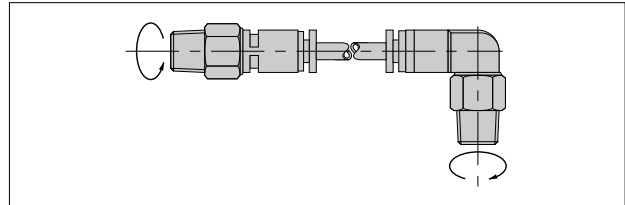

3. Not-recommended example

If the tubing will be moving in a swinging motion (or in the directions of the arrows in the diagram), we suggest using Polyurethane tubing and /or parts in the High Rotary Joint series.

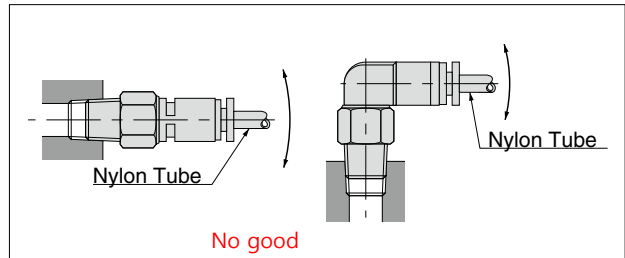

■ How to connect and disconnect

1. How to connect and disconnect tubes

① Tube insertion

Push in a tubing up to the very end. Lock-claws bite the tubing and hold it automatically while the elastic sleeve seals around the tubing.

Refer to "2. Instructions for Tube Insertion" under "Common Safety Instructions for Fittings" .

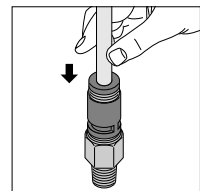

② Tube disconnection

The tubing is pulled out by pushing the release-ring which opens the Lock-claws.

Make sure turning off the air supply before the tubing disconnection.

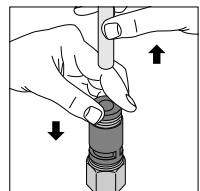

2. How to tighten thread

① Tightening thread

Use a spanner to tighten a hexagonal-column.

Refer to "Table 2: Recommended tightening torque / Sealock color / Gasket materials" under "4. Instructions for Installing a fitting" in "Common Safety Instructions for Fittings".

* . Be careful not to tighten the thread with excessive tightening torque. It may result in deform of the product, rotation problem or fluid leakage.

