

■ Characteristics

- *Blow-Off Mechanism can be selectable from solenoid valve type and air timer (air chamber) type. The built-in switching valve realizes fine tuning of quick blow-off air and fine adjustment of air rate.*
- *Easy maintenance by a lock-on manual button.*
- *2 vacuum sensor selections: LED display Type and Mechanical Type which is simple and user-friendly.*
- *An LED display is used for LED digital pressure sensor to enhance visibility.*
- *Two types of vacuum switch : 2 switch output, 1 switch output with 1 analog output are available depending on the desired application.*
- *4 Standard nozzle bores are 05(\varnothing 0.5mm), 07(\varnothing 0.7mm), 10(\varnothing 1.0mm) and 12(\varnothing 1.2mm).*

Piping Example

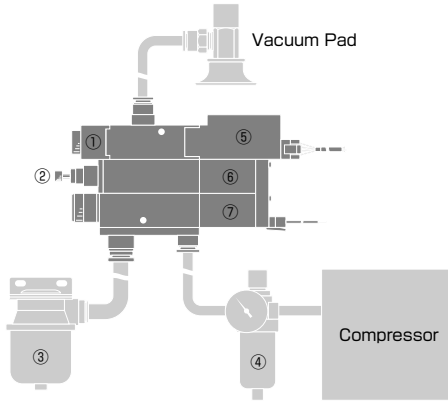

- ① Filter
Dusts sucked up from a vacuum pad are filtered and blocked from entering inside the vacuum generator.
- ② Blow-off air rate adjustment needle
Turning the release needle to right (clockwise direction) reduces blow-off air and turning it to left (counterclockwise) increases blow-off air.
- ③ Vacuum Filter
Dusts and water drops exhausted from the vacuum generator are filtered.
- ④ Filter / Regulator
Select a filter and a regulator which ensure an adequate flow pressure and rate of VK.
- ⑤ Vacuum Sensor with LED display
Easy adjustment of vacuum level by the LED display. 2 types of output are available; ① 2 switch output and ② 1 switch output with analog output.
- ⑥ Blow-off Solenoid Valve (R)
The solenoid valve functions to release a work-piece from a vacuum pad.
(Blow-off air is generated during the electric power supply)
- ⑦ Suction Solenoid Valve (S)
The solenoid valve generates vacuum.

Construction (Stand-alone type with double side port : VKA)

VKA□□□W··Blow-off solenoid valve type (Solenoid valve: Normally closed)

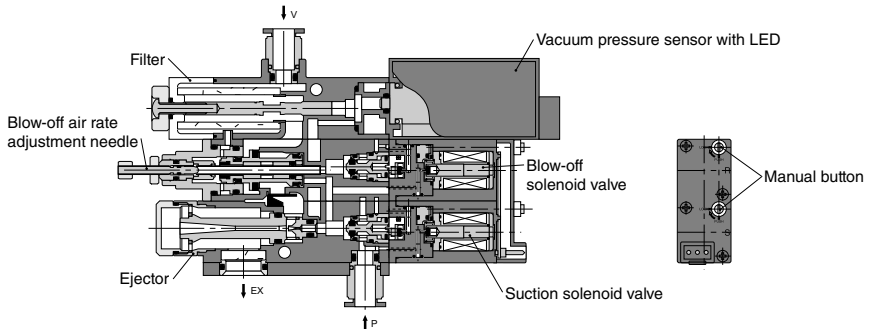

Construction (VKB: Stand-alone type with single side port)

VKB□□□Q··Air timer type (Solenoid valve: Normally closed)

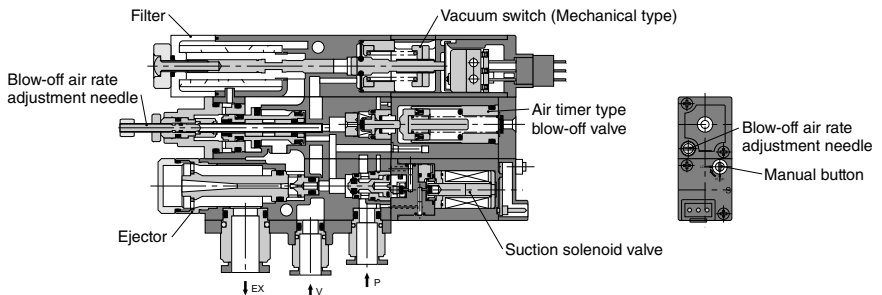



Model Designation (Example)

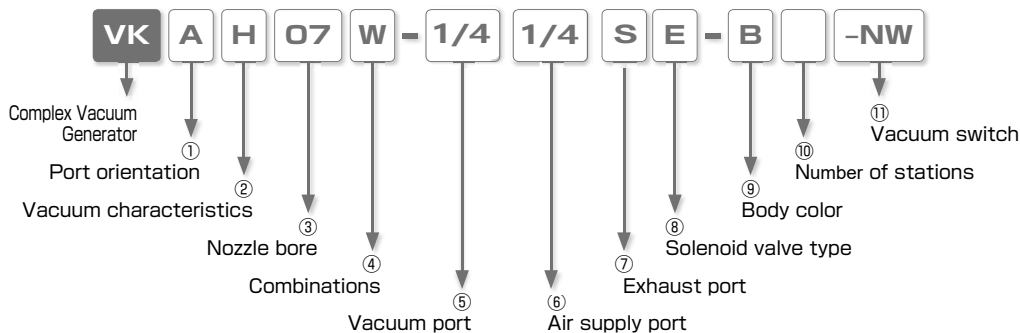

① Port orientation

Code		Code		Code	
A	Stand-alone type with double side port	B	Stand-alone type with single side port	M	Manifold type

② Vacuum characteristics

Code	Performance	Code	Performance	Code	Performance
H	High-vacuum type (Rated supply pressure) 72.5 psi (0.5MPa)	L	Large-flow type (Rated supply pressure) 72.5 psi (0.5MPa)	E	High-vacuum at low air supply pressure type (Rated supply pressure) 50 psi (0.35MPa)
No code	Manifold-base alone				

③ Nozzle bore. (Combinations: A, C, E, G, J, L, P, Q, R, S, T and W)

Code	Nozzle bore	H type Vacuum level and Suction flow	L type Vacuum level and Suction flow	E type Vacuum level and Suction flow	Air consumption
05	0.5mm	-26.8inHg, 0.25scfm (-91kPa, 7ℓ/min[ANR])	-19.8inHg, 0.42scfm (-67kPa, 12ℓ/min[ANR])	-	0.41scfm (11.5ℓ/min[ANR])
07	0.7mm	-27.6inHg, 0.46scfm (-93kPa, 13ℓ/min[ANR])	-19.8inHg, 0.91scfm (-67kPa, 26ℓ/min[ANR])	-27inHg, 0.37scfm (-91kPa, 10.5ℓ/min[ANR])	0.81scfm (0.60scfm) (23ℓ/min[ANR])(17ℓ/min[ANR])
10	1.0mm	-27.6inHg, 0.95scfm (-93kPa, 27ℓ/min[ANR])	-19.8inHg, 1.40scfm (-67kPa, 40ℓ/min[ANR])	-27inHg, 0.37scfm (-91kPa, 21ℓ/min[ANR])	1.63scfm (1.20scfm) (46ℓ/min[ANR])(34ℓ/min[ANR])
12	1.2mm	-27.6inHg, 1.33scfm (-93kPa, 38ℓ/min[ANR])	-19.8inHg, 1.75scfm (-67kPa, 50ℓ/min[ANR])	-27inHg, 0.95scfm (-91kPa, 27ℓ/min[ANR])	2.47scfm (1.67scfm) (70ℓ/min[ANR])(47ℓ/min[ANR])
No code	Manifold-base alone				

Nozzle bore. (Combinations: B, D, F, H, K and M)

Code	Nozzle bore	H type Vacuum level and Suction flow	L type Vacuum level and Suction flow	E type Vacuum level and Suction flow	Air consumption
05	0.5mm	-25.5inHg, 0.19scfm (-86.5kPa, 5.4ℓ/min[ANR])	-19.6inHg, 0.35scfm (-66.5kPa, 10ℓ/min[ANR])	-	0.41scfm (11.5ℓ/min[ANR])
07	0.7mm	-26.7inHg, 0.39scfm (-90.5kPa, 11ℓ/min[ANR])	-19.6inHg, 0.67scfm (-66.5kPa, 19ℓ/min[ANR])	-25.5inHg, 0.30scfm (-86.5kPa, 8.4ℓ/min[ANR])	0.81scfm (0.60scfm) (23ℓ/min[ANR])(17ℓ/min[ANR])
10	1.0mm	-26.7inHg, 0.67scfm (-90.5kPa, 19ℓ/min[ANR])	-19.6inHg, 0.85scfm (-66.5kPa, 24ℓ/min[ANR])	-25.5inHg, 0.54scfm (-86.5kPa, 15.4ℓ/min[ANR])	1.63scfm (1.20scfm) (46ℓ/min[ANR])(34ℓ/min[ANR])
12	1.2mm	-26.7inHg, 0.85scfm (-90.5kPa, 24ℓ/min[ANR])	-19.6inHg, 0.95scfm (-66.5kPa, 27ℓ/min[ANR])	-25.5inHg, 0.67scfm (-86.5kPa, 19ℓ/min[ANR])	2.47scfm (1.67scfm) (70ℓ/min[ANR])(47ℓ/min[ANR])
No code	Manifold-base alone				

※ Suction flow of the vacuum port size with 5/32" O.D. and \varnothing 4mm may be different from the above values.

※ Supply pressure is 72.5psi (0.5MPa) for H and L type and 50psi (0.35MPa) for E type.

※ Air consumption values in () represents that of E type.

※ The values in the table are reference values only. Suction flow varies according to the vacuum system conditions; vacuum port dia. or tube length.

④ Combinations (18 types)

Code	A	B	C	D	E	F	G	H	J	K	L	M	P	Q	R	S	T	W
Filter	○	○	○	○	○	○	○	○	○	○	○	○	○	○	○	○	○	○
Suction solenoid valve	—	—	—	—	—	—	○	○	○	○	○	○	○	○	○	○	○	○
Check valve (vacuum retention feature)	—	○	○	○	—	○	—	○	—	○	—	○	—	—	—	—	—	—
Mechanical vacuum switch	—	—	○	○	—	—	—	—	○	○	—	—	—	○	—	—	—	○
Vacuum switch with LED display	—	—	—	—	○	○	—	—	—	—	○	○	—	—	○	—	—	○
Air timer type blow-off valve	—	—	—	—	—	—	—	—	—	—	—	—	○	○	○	—	—	—
Solenoid valve type blow-off pilot valve	—	—	—	—	—	—	—	—	—	—	—	—	—	—	—	○	○	○
No code	Manifold-base alone																	

⑤ Vacuum port (tube dia.)

■ Stand-alone type

	inch size			mm size		
Code	5/32	1/4	5/16	04	06	08
Tube dia.	ø5/32	ø1/4	ø5/16	ø4	ø6	ø8

※ 5/32" (code: 5/32) and ø4mm (code: 04) is selectable for Nozzle Bore 0.5mm and 0.7mm only.

■ Manifold type (VKM)

Port position	inch size							mm size						
	Side (Straight)				Top (Straight)			Side (Straight)				Top (Straight)		
Code	S5/32	S1/4	S5/16	PP	T5/32	T1/4	T5/16	S4	S6	S8	PP	T4	T6	T8
Tube dia.	ø5/32	ø1/4	ø5/16	Plug	ø5/32	ø1/4	ø5/16	ø4	ø6	ø8	Plug	ø4	ø6	ø8

00 : Applicable to a manifold installation top-mounting unit alone, with the port to be installed on the side and to model code for manifold-base alone with different vacuum port size.

※1. 5/32" (code: 5/32) and ø4mm (code: 04) is selectable for Nozzle Bore 0.5mm and 0.7mm only.

※2. Refer to the Manifold Type reference picture to select the port position.

⑥ Air supply port (tube dia.)

■ Stand-alone type

	inch size			mm size		
Code	5/32	1/4	5/16	04	06	08
Tube dia.	ø5/32	ø1/4	ø5/16	ø4	ø6	ø8

※ 5/32" (code: 5/32) and ø4mm (code: 04) is selectable for Nozzle Bore 0.5mm and 0.7mm only.

■ Manifold type (VKM)

Port type	inch size							mm size						
	Straight				Elbow			Straight				Elbow		
Code R side only Both sides L side only	1 1/4	1 5/16	1 3/8	1 1/2	4 5/16	4 3/8	4 1/2	16	18	10	12	48	40	42
	2 1/4	2 5/16	2 3/8	2 1/2	5 5/16	5 3/8	5 1/2	26	28	20	22	58	50	52
	3 1/4	3 5/16	3 3/8	3 1/2	6 5/16	6 3/8	6 1/2	36	38	30	32	68	60	62
Tube dia.	ø1/4	ø5/16	ø3/8	ø1/2	ø5/16	ø3/8	ø1/2	ø6	ø8	ø10	ø12	ø8	ø10	ø12

00 : Applicable to a manifold installation top-mounting unit alone.

⑦ Exhaust port (tube dia.)

■ Stand-alone type

Code	S	08	L8
Tube dia.	Silencer vent	ø8mm Straight type 8mm is same as 5/16" (tube exhaust)	ø8mm Elbow type 8mm is same as 5/16" (tube exhaust)

■ Manifold type (VKM)

inch size												
Port type		Silencer vent	Tube exhaust									
			Straight			Elbow			Female taper thread			
c o d e	R side only	S1	1 5/16	1 3/8	1 1/2	1 5/8	4 5/16	4 3/8	4 1/2	72N	73N	74N
	Both sides	S2	2 5/16	2 3/8	2 1/2	2 5/8	5 5/16	5 3/8	5 1/2	82N	83N	84N
	L side only	S3	3 5/16	3 3/8	3 1/2	3 5/8	6 5/16	6 3/8	6 1/2	92N	93N	94N
Tube dia.		—	ø5/16	ø3/8	ø1/2	ø5/8	ø5/16	ø3/8	ø1/2	1/4NPT	3/8NPT	1/2NPT

mm size												
Port type		Silencer vent	Tube exhaust									
			Straight			Elbow			Female taper thread			
c o d e	R side only	S1	18	10	12	13	48	40	42	72	73	74
	Both sides	S2	28	20	22	23	58	50	52	82	83	84
	L side only	S3	38	30	32	33	68	60	62	92	93	94
Tube dia. (mm)		—	ø8	ø10	ø12	ø16	ø8	ø10	ø12	Rc1/4	Rc3/8	Rc1/2

00 : Applicable to a manifold installation top-mounting unit alone.

⑧ Solenoid valve type

Voltage	DC24V	AC100V
Normally closed (N.C.)	E	F
Normally open (N.O.)	G	H

No code : Manifold-base alone

※ The above codes are selectable when a suction solenoid valve or/and a blow-off solenoid valve are selected.

⑨ Color

Code	W	B
Color	Light-gray	Black

⑩ Number of stations (Manifold type only)

Code	02	03	04	05	06	07	08	09	10
# of stations	2	3	4	5	6	7	8	9	10

※ Special-order for those with 11 or more stations.

⑪ Vaccum switch (※ Selectable only when ④ Combinations is one of E, F, L, M, R and W)

Code	-NW	-NA	-PW	-PA
Switch output	NPN open collector output with 2 switch outputs	NPN open collector switch output and analog output	PNP open collector output with 2 switch outputs	PNP open collector switch output with analog output

Vacuum Generator Series

Vacuum Generator VK

Model Designation of Block Plate (Example)

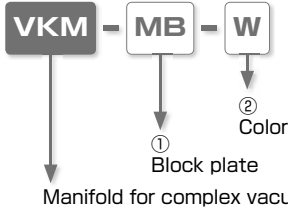

① Block plate : MB

② Color

Code	W	B
Color	Light-gray	Black

Model Designation of Nozzle Set (Example)

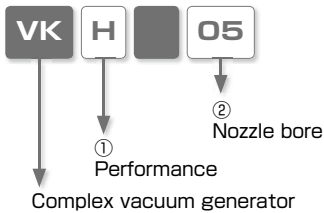

① Complex vacuum generator

Code	Vacuum characteristics	Code	Vacuum characteristics	Code	Vacuum characteristics
H	High-vacuum type (Rated supply pressure) 72.5 psi (0.5MPa)	L	Large-flow type (Rated supply pressure) 72.5 psi (0.5MPa)	E	High-vacuum at low air supply pressure type (Rated supply pressure) 50 psi (0.35MPa)

※ E type does not have Nozzle Bore 0.5mm.

② Nozzle bore

Code	05	07	10	12
Nozzle bore	0.5mm	0.7mm	1.0mm	1.2mm

Order Example

Manifold type (VKM)

Example 1. When all stations have common specifications.

VK M H 10 W - T6 20 S2 E - B 04 - NW
① ② ③ ④ ⑤ ⑥ ⑦ ⑧ ⑨ ⑩ ⑪

- ① Port orientation : **M** → Manifold
- ② Vacuum characteristics : **H** → Hgh-vacuum type
- ③ Nozzle bore : **10** → ø1.0mm
- ④ Combinations : **W** → Filter, Suction solenoid valve, Vacuum switch with LED display and Blow-off solenoid valve
- ⑤ Vacuum port : **T6** → ø6mm Push-In Fitting on top
- ⑥ Air supply port : **20** → ø10mm Push-In Fittings on both sides of manifold
- ⑦ Exhaust port : **S2** → Silencers on both sides of manifold
- ⑧ Solenoid valve type : **E** → Normally closed (N.C) type 24VDC
- ⑨ Color : **B** → Black
- ⑩ Number of stations : **04** → 4 stations
- ⑪ Switch output : **NW** → NPN open collector output with 2 switch output

Manifold installation top-mounting unit alone

Example 2. When vacuum port is installed on the side of the manifold-base.

VK M H 07 G - 00 00 00 E - W
① ② ③ ④ ⑤ ⑥ ⑦ ⑧ ⑨

- ① Port orientation : **M** → Manifold type
- ② Vacuum characteristics : **H** → High-vacuum type
- ③ Nozzle bore : **07** → ø0.7mm
- ④ Combinations : **G** → Filter and Suction solenoid valve
- ⑤ Vacuum port : **00** → Applicable to installation on the side (front) of a manifold
- ⑥ Air supply port : **00** → Applicable to a manifold installation top-mounting unit alone
- ⑦ Exhaust port : **00** → Applicable to a manifold installation top-mounting unit alone
- ⑧ Solenoid valve type : **E** → "Normally Closed" (N.C.) type 24VDC (for both suction and blow-off)
- ⑨ Color : **W** → Light-gray

Example 3. When vacuum port is installed on the upper plane of the station

VK M H 12 R - T1/4 00 00 E - W - NA
① ② ③ ④ ⑤ ⑥ ⑦ ⑧ ⑨ ⑪

- ① Port orientation : **M** → Manifold
- ② Vacuum characteristics : **H** → Hgh-vacuum type
- ③ Nozzle bore : **12** → ø1.2mm
- ④ Combinations : **R** → Filter, Suction solenoid valve, Vacuum switch with LED display and Air timer type blow-off valve
- ⑤ Vacuum port : **T1/4** → ø1/4" Push-In Fitting on top
- ⑥ Air supply port : **00** → Applicable to a manifold installation top-mounting unit alone
- ⑦ Exhaust port : **00** → Applicable to a manifold installation top-mounting unit alone
- ⑧ Solenoid valve type : **E** → "Normally closed" (N.C.) type 24VDC (for both suction and blow-off)
- ⑨ Color : **W** → Light-gray
- ⑪ Vacuum switch : **NA** → NPN open collector switch output and analog output

Note) For manifold installation top-mounting unit, vacuum ports are provided with a seal packing and two threads.
 (Seals are not provided for exhaust port and supply port. → Instead, they are attached to manifolds)

Vacuum Generator Series

Vacuum Generator VK

Order Example

Manifold-base only (Block plate not attaching to the top unit)

Example 4. When all vacuum ports are common specifications

VKM - S1/4 43/8 61/2 -W 08

① ⑤ ⑥ ⑦ ⑨ ⑩

- ① Port orientation : **M** → Manifold type
- ⑤ Vacuum port : **S1/4** → $\varnothing 1/4$ " Push-In Fitting for each of 8 stations
- ⑥ Air supply port : **4 3/8** → R side only, $\varnothing 3/8$ " Push-In Fitting (Elbow)
- ⑦ Exhaust port : **6 1/2** → L side only, $\varnothing 1/2$ " Push-In Fitting (Elbow)
- ⑨ Color : **W** → Light-gray
- ⑩ Number of stations : **08** → 8 stations

Example 5. When the vacuum ports differ even by one (Fill out the Specification Order Form on page 128)

VKM - 00 48 62 -W 08

① ⑤ ⑥ ⑦ ⑨ ⑩

- ① Port orientation : **M** → Manifold type
- ⑤ Vacuum port : **00** → When a vacuum port at any station differs in a manifolds (Specification Order Form is required separately)
- ⑥ Air supply port : **48** → R side only, $\varnothing 8$ mm Push-In Fitting (Elbow)
- ⑦ Exhaust port : **62** → L side only, $\varnothing 12$ mm Push-In Fitting (Elbow)
- ⑨ Color : **W** → Light-gray
- ⑩ Number of stations : **08** → 8 stations

Example of entry in specification form when vacuum port differ even by one

		Config. (Port pos.) ①	Vacuum characteristics ②	Nozzle bore. ③	Combinations ④	Vacuum port ⑤	Air supply port ⑥	Exhaust port ⑦	Solenoid valve ⑧	Color ⑨	Number of stations ⑩	Vacuum switch with LED display ⑪	
Manifold model code		VKM		—		00	48	62	—	W	08		
Top- Mounting unit model	L	St.1				S6							
	↑	St.2				S6							
	S t a t i o n #	St.3					S6						
		St.4					S6						
		St.5					S8						
		St.6					S8						
	↓	St.7				S8							
	St.8					PP							
	St.9												
	R	St.10											

Note1) Enter the column of Manifold model code. For entries into the vacuum port column (5), use only side port codes (S4, S6, S8, or PP)

Vacuum Generator Series

Vacuum Generator VK

■ Instructions for Specification order form

- (1) In case of manifold installation top-mounting unit example 1) and 2) of ② "Model code and number of units of manifold installation top-mounting unit", ⑤ "Vacuum port" is "00" which indicates ports on sides, but does not show the tube dia. of fittings. Tube dia. of the fitting should be designated by ④ "Specification Order Form". Therefore, there may be a difference in format style between the model code in ② and ④ "Specification order form" as to the Vacuum port space ⑤.
- (2) Station numbers are arranged in serial order as St 1, St 2, ...St 10 form the L side toward R side. To confirm the positions of the L and R sides, see the Manifold Type reference picture below.
- (3) If the manifold installation top-mounting units for St 1, St 2 and St 3 are of the same specifications as in the above example of specification order form, fill up the "St 1" space (uppermost) only, while entering St 1 in each of the St 2 and St 3 grids on the Config. (port pos.) column ①. (For example, if the manifold installation top-mounting unit for St 6 happens to be the same model as that of St 1, enter "St 1" in St 6's grid on the Config. (port pos.) column ①).
On the right-hand edge column are grids to enter the number of common units for respective St numbers. Remember to fill in these grids as a verification of the number of common units per manifold.
With respect to solenoid valves, we have, in principle, unified working voltage.
Therefore, different working voltage can not be selected in one manifold order. However, we can provide either N.O. or N.C. type if the two types are of the same working voltage, so it is possible to choose one as with the case of solenoid valve type ⑧.

■ Example of Manifold Type

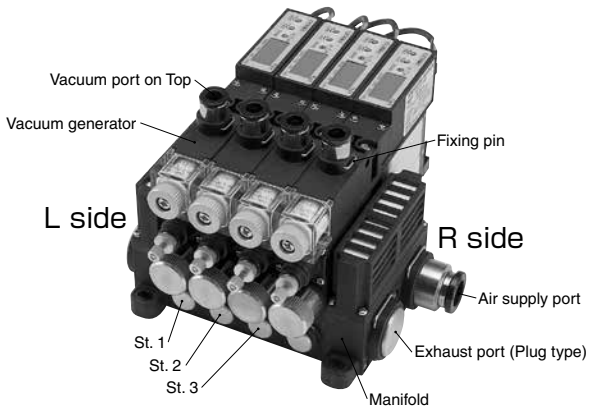

Vacuum Generator VK Series Specification Order Form

To: NIHON PISCO CO., Ltd.

Name : _____

Order # : _____

Date : _____

Requested EX-W PISCO Date : _____ Quantity : _____

		Config. (Port pos.)	Vacuum characteristics	Nozzle bore.	Combinations	Vacuum port	Air supply port	Exhaust port	Solenoid valve	Color	Number of stations	Vacuum switch with LED display	For PISCO use only	
		①	②	③	④	⑤	⑥	⑦	⑧	⑨	⑩	⑪		
Manifold model code		VKM	—						—					
Top- Mounting unit model code	L ↑	St.1												
		St.2												
		St.3												
		St.4												
		St.5												
	S t a t i o n . # ↓ R	St.6												
		St.7												
		St.8												
		St.9												
		St.10												

- ※ Make a copy of this page and fill in the code referring to model designation example.
- ※ Enter the quantity of common units in ⑩ Number of stations.



Specification (Supply pressure)

Fluid medium	Air
Operating pressure range	36~101.5psi (0.25 ~ 0.7 MPa)
Rated supply pressure	H and L type : 72.5psi (0.5 MPa)、E type : 50.8psi (0.35 MPa)
Operating temp. range	40 ~ 122°F (5 ~ 50°C) (No freezing)
Lubrication	Not required

Ejector characteristics

Model code	Nozzle bore. mm	Supply pressure	Final vacuum	Suction flow	Air consumption	Replacement Nozzle set model code
		psi (MPa)	-inHg (-kPa)	scfm (ℓ /min(ANR))	scfm (ℓ /min(ANR))	
VK□H05…	0.5	72.5 (0.5)	26.9 (91)	0.25 (7)	0.41 (11.5)	VK HN05
		50.8 (0.35)	21.5 (73)		0.32 (9)	
VK□L05…		72.5 (0.5)	19.8 (67)	0.39 (11)	0.41 (11.5)	VK LN05
VK□H07…	0.7	72.5 (0.5)	27.4 (93)	0.46 (13)	0.81 (23)	VK HN07
		50.8 (0.35)	21.5 (73)		0.60 (17)	
VK□L07…		72.5 (0.5)	19.8 (67)	0.91 (26)	0.81 (23)	VK LN07
VK□E07…		50.8 (0.35)	26.8 (91)	0.37 (10.5)	0.60 (17)	VK EN07
VK□H10…	1.0	72.5 (0.5)	27.4 (93)	0.95 (27)	1.63 (46)	VK HN10
		50.8 (0.35)	21.5 (73)		1.20 (34)	
VK□L10…		72.5 (0.5)	19.8 (67)	1.40 (40)	1.63 (46)	VK LN10
VK□E10…		50.8 (0.35)	26.8 (91)	0.74 (21)	1.20 (34)	VK EN10
VK□H12…	1.2	72.5 (0.5)	27.4 (93)	1.33 (38)	2.47 (70)	VK HN12
		50.8 (0.35)	21.5 (73)		1.67 (47)	
VK□L12…		72.5 (0.5)	19.8 (67)	1.75 (50)	2.47 (70)	VK LN12
VK□E12…		50.8 (0.35)	26.8 (91)	0.95 (27)	1.67 (47)	VK EN12

※ 1. Secure supply pressure as listed when the vacuum generator is in operation. (Take pressure drop into account.)

※ 2. The values in the table are reference values only. Suction flow varies according to the vacuum system conditions; vacuum port dia. or tube length.

※ 3. The values in the dark highlight show the characteristics at the rated supply pressure.

Solenoid valve (Suction solenoid valve / Blow-off solenoid valve)

Structure	Suction solenoid valve (Code: S)				Blow-off solenoid valve (Code: R)	
	DC24V		AC100V		DC24V	AC100V
Rated voltage	DC21.6 ~ 26.4V (DC24V \pm 10%)		AC90 ~ 110V (AC100V \pm 10%)		DC21.6 ~ 26.4V (DC24V \pm 10%)	AC90 ~ 110V (AC100V \pm 10%)
Surge protection circuit	Surge absorber		Diode bridge		Surge absorber	Diode bridge
Power consumption	0.8W		1VA		0.8W	1VA
Valve type	Pilot valve					
Insulation system	Equal to class B					
Manual operation	Push-lock button					
Operation indicator	Coil excitation: Red LED ON					
Wire connection method and lead wire length	Connector : 500mm					
Proof pressure	1.05MPa (152psi)					
Conduction	N.C.	N.O.	N.C.	N.O.	N.C.	
Effective sectional area	3.5 mm ²				0.6 mm ²	

Filter specification

Element material	PVF (Polyvinyl formal)
Filtering capacity	10μm
Filter area	1,130mm ²
Replacement element model code	VGFE 10

Air timer type blow-off valve

Structure	Delay style by air timer cylinder, Poppet valve, Two-way valve
Release time	Approx. 0.3 to 3sec after closing of suction solenoid
Blow-off air rate	0 ~ 1.4scfm (0 ~ 40l/min(ANR)) - supply pressure at 72.5psi (0.5MPa)
Timer setting method	Control by the speed controller of air timer cylinder

Lead Wire Color

With suction solenoid valve only		With combination of suction & blow-off solenoid valve	
DC24V	AC100V	DC24V	AC100V
Red (+) Black (-)	Blue	Black (- : Suction solenoid valve) Red (+ : Common) White (- : Blow-off solenoid valve)	White (Common) Blue (Suction solenoid valve) Black (Blow-off solenoid valve)

Vacuum Retention Function (Combinations: B, D, F, H, K, M, S, T and W)

Allowable vacuum leakage	1.3kPa (1.38inHg)/10min. or less
--------------------------	----------------------------------

Note) In case of applying vacuum retention for long period, take above specification into consideration.

Mechanical-type Vacuum Switch Specification

Pressure detection	Diaphragm - Micro switch
Pressure setting range	-5.9 ~ -23.6inHg (-20 ~ -80kPa)
Setting mode	Nut rotation (stepless adjustment)
Switch terminal	Common, N.O., N.C.
Accuracy	±1.2inHg (4kPa)
Differential response	4.43inHg (16kPa) or less
Micro switch	QJ (AM8100) Matsushita Electric or J-7 OMRON
Micro switch rating	7A 250V AC



Vacuum switch with LED display

■ NPN open collector

Output	2 switch output (-NW)	1 switch output and 1 analog output (-NA)
Current consumption	40mA or less	
Pressure detection	Diffused metaloxide semiconductive pressure transducer	
Operating pressure range	0 ~ -29.5inHg (0 ~ -100kPa)	
Pressure setting range	0 ~ -99kPa	
Proof pressure	29psi (0.2MPa)	
Operating temp. range	32 ~ 120°F (0 ~ 50°C) (No freezing)	
Operating humidity range	35 ~ 85%RH (No dew condensation)	
Power requirements	12 ~ 24VDC ± 10% Ripple (P-P) 10% max.	
Protective structure	IEC standard IP40 equiv.	
# of pressure setting	2	1
Operating accuracy	±3%F.S. max. (at Ta=25°C)	
Differential response	Fixed (2%F.S. max.)	Variable (about 0 ~ 15% of set value)
Switch output	NPN open collector output: 30V 80mA max. Residual voltage 0.8V max.	
Analog output	Output voltage	1 ~ 5V
	Zero-point voltage	1±0.1V
	Span voltage	4±0.1V
	Output current	Output current: 1mA max. (load resistance 50kΩ max.)
	LIN / HYS	±0.5%F.S. max.
Differential response	approx. 2m-sec max.	
Indication	0 ~ -99kPa (2-digit red LED display)	
Display frequency	About 4 times / sec.	
Indication accuracy	±3%F.S. ±2 digit	
Sensor resolution	1 digit	
Operational indication	SW1: Red LED turns ON, when pressure is above the setting	Red LED turns ON, when pressure is above the setting
	SW2: Green LED turns ON, when pressure is above the setting	
Function	1. MODE selector switch (ME / S1 / S2)	1. MODE selector switch (ME / SW)
	2. S1 setting trimmer (2/3-turn trimmer)	2. SW setting trimmer (2/3- turn trimmer)
	3. S2 setting trimmer (2/3- turn trimmer)	3. HYS setting trimmer (About 0-15% of setting value)

■ PNP open collector

Output	2 switch output (-PW)	1 switch and 1 analog output (-PA)		
Current consumption	40mA or less			
Pressure detection	Diffused metaloxide semiconductive pressure transducer			
Operating pressure range	0 ~ -29.5inHg (0 ~ -100kPa)			
Pressure setting range	0 ~ -99kPa			
Proof pressure	29psi (0.2MPa)			
Operating temp. range	32 ~ 120°F (0 ~ 50°C) (No freezing)			
Operating humidity range	35 ~ 85%RH (No dew condensation)			
Power requirements	12 ~ 24VDC ± 10% Ripple (P-P) 10% max.			
Protective structure	IEC standard IP40 equiv.			
# of pressure setting	2	1		
Operating accuracy	±3%F.S. max. (at Ta=25°C)			
Differential response	Fixed (2%F.S. max.)	Variable (about 0 ~ 15% of set value)		
Switch output	PNP open collector output: Supply voltage 80mA max. Residual			
Analog output	/		Output voltage	1 ~ 5V
			Zero-point voltage	1±0.1V
			Span voltage	4±0.1V
			Output current	Output current: 1mA max. (load resistance 50kΩ max.)
			LIN/HYS	±0.5%F.S. max.
Differential response	approx. 2m-sec max.			
Indication	0 ~ -99kPa (2-digit red LED display)			
Display frequency	About 4 times / sec.			
Indication accuracy	±3%F.S. ±2 digit			
Sensor resolution	1 digit			
Operational indication	SW1: Red LED turns ON, when pressure is above the setting SW2: Green LED turns ON, when pressure is above the setting	Red LED turns ON, when pressure is above the setting		
Function	1. MODE selector switch (ME / S1 / S2)	1. MODE selector switch (ME / SW)		
	2. S1 setting trimmer (2/3-turn trimmer)	2. SW setting trimmer (2/3- turn trimmer)		
	3. S2 setting trimmer (2/3- turn trimmer)	3. HYS setting trimmer (About 0-15% of setting value)		

Vacuum Generator Series

Vacuum Generator VK

Mechanism of VKA

Example) VKA□□□W……E

Solenoid valve type (Normally closed) / Blow-off solenoid valve / Filter / Vacuum switch with LED

① At vacuum generation suspended

② At vacuum generating

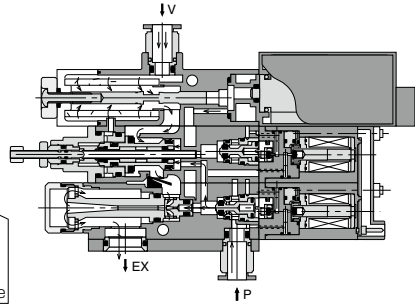
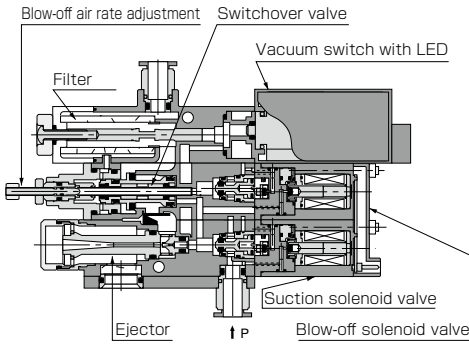

③ At vacuum retention

④ At blowing-off

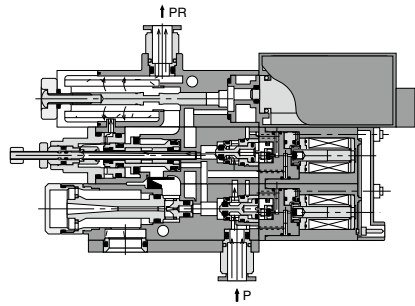
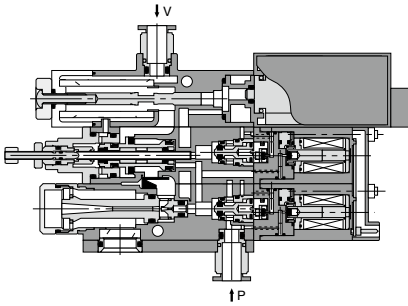

VKA circuit diagram

Example) VKA□□□W……E

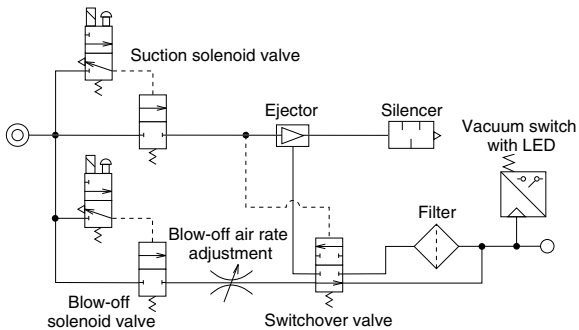

Mechanism of VKB

Example) VKB□□□Q……E

Solenoid valve type (Normally closed) / Air timer type blow-off valve / Filter / Mechanical vacuum switch

① At vacuum generation suspended

② At vacuum generating

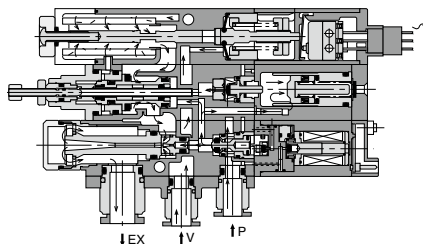
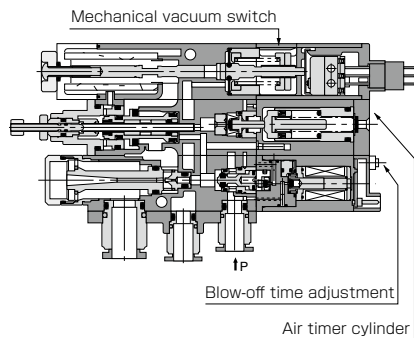

③ Blow-off (Immediately after turning off Suction solenoid valve)

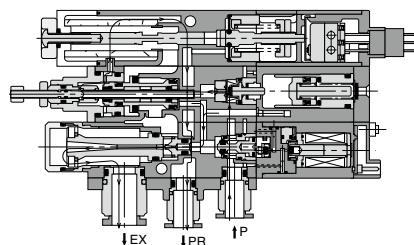

VKB circuit diagram

Example) VKB□□□Q……E

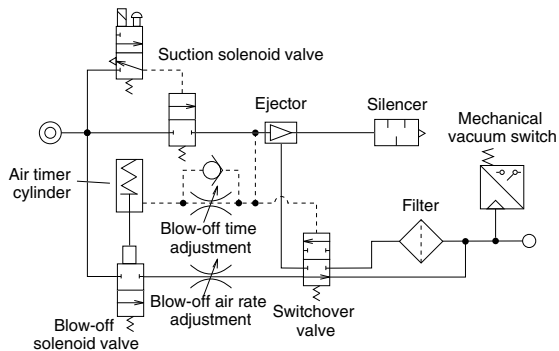

Characteristics

Supply pressure - Final vacuum, Suction Flow, Air Consumption

VKAH05, VKAL05, VKBH05, VKBL05, VKMH05, VKML05

Vacuum characteristics

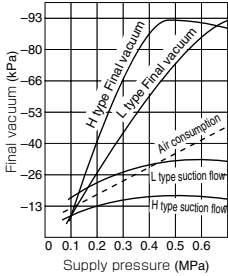

Flow characteristics

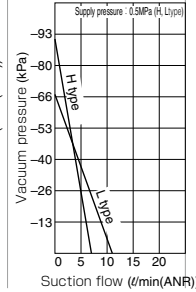

VKAH07, VKAL07, VKAE07, VKBH07, VKBL07, VKBE07, VKMH07, VKML07, VKME07

Vacuum characteristics

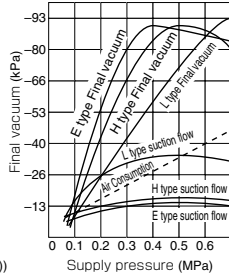

Flow characteristics

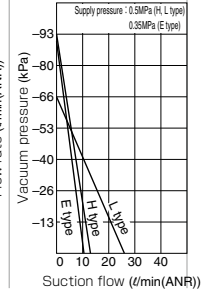

VKAH10, VKAL10, VKAE10, VKBH10, VKBL10, VKBE10, VKMH10, VKML10, VKME10

Vacuum characteristics

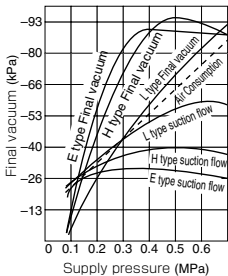

Flow characteristics

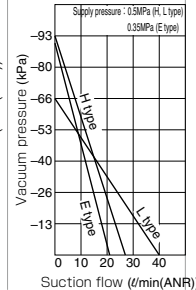

VKAH12, VKAL12, VKAE12, VKBH12, VKBL12, VKBE12, VKMH12, VKML12, VKME12

Vacuum characteristics

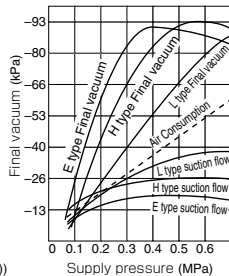

Flow characteristics

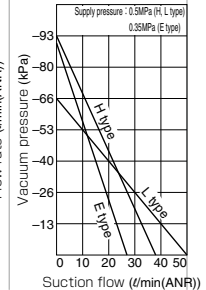

- In the characteristics shown above, supply pressures refer to those when vacuum is generated.
- In the characteristics shown above, an odd noise may be heard when supply pressures are immediately before the peak of vacuum levels (H (High vacuum) type: 0.4~0.45MPa, and E (High-vacuum at low air supply pressure type) type: 0.29~0.32MPa). The sounding of this odd noise means the characteristics are unstable. If nothing is done, the sound may become even noisier. This situation can also adversely affect the sensor, resulting in a malfunction or trouble. So reset the supply pressure.

(Ex. 1: When the vacuum generator H type is in operation with the original pressure of 0.5MPa, the odd noise began to be heard due to a drop in supply pressure to 0.43MPa. Reset the supply pressure for the vacuum generator in operation at 0.5MPa.)
- Piping design and equipment selection should be made with an effective sectional area being 3 times as large as the nozzle diameter as a standard. Satisfactory vacuum characteristics are not obtained unless sufficient supply air flow is secured. (For example, the odd noise is heard even when pressure is at the set value, suction flow is insufficient, the final vacuum does not satisfy the required level, etc.)

(Example2. There is the odd noise from the vacuum generator H type, though the supply pressure is 0.5MPa. → Insufficient supplied air rate is the cause. The supplied air rate is reduced before the vacuum generator by a pipe resistance, and a proper air rate is not obtained. Select tubes and pneumatic apparatuses with the target effective cross-section areas obtaining the necessary air flow rate.)

(Example3. When $\phi 1.0\text{mm}$ of nozzle bore is selected, the effective cross-section size should be more than 2.35mm^2 . (cross-section $0.5 \times \pi \times 7 = 0.785 \text{ mm}^2 \times 3 = 2.35 \text{ mm}^2$). Select tubes and pneumatic apparatuses with the effective cross-section area more than 2.3 mm^2 .)

Electric circuit diagram (Solenoid valve)

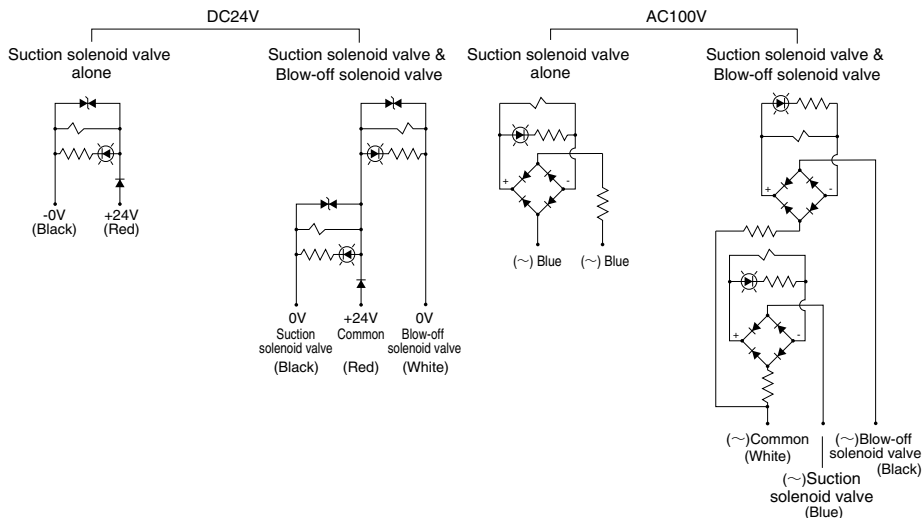

How to insert and disconnect

1. How to insert and disconnect tubes

① Tube insertion

Insert a tube into Push-In Fitting of the vacuum generator VK up to the tube end. Lock-claws bite the tube to fix it and the elastic sleeve seals around the tube. Refer to "2. Instructions for Tube Insertion" under "Common Safety Instructions for Fittings" .

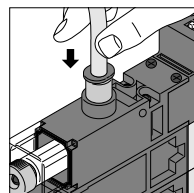

② Tube disconnection

The tube is disconnected by pushing release-ring to release Lock-claws. Make sure to stop air supply before the tube disconnection.

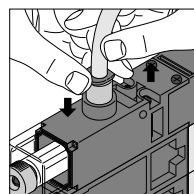

2. How to fix the product

In order to fix the vacuum generator VK, tighten M3 threads through the fixing holes on the resin body with tightening torque 0.4 to 0.5Nm. Refer to the outer dimensional drawings for the hole pitch.

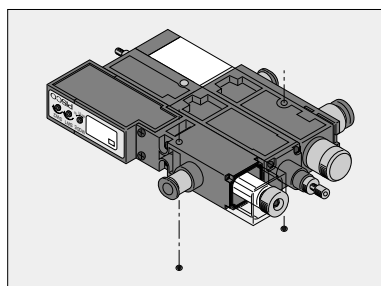

Vacuum Generator Series

Vacuum Generator VK

VK Series Weight List

Combination code	Stand-alone weight (g)		Manifold weight (g)	
	VKA...	VKB...	VKM...S...	VKM...T...
A	60	60	75.5	77.5
B	60	60	75.5	77.5
C	78.5	78.5	94	96
D	78.5	78.5	94	96
E	84.5	84.5	100	102
F	84.5	84.5	100	102
G	81	81	96.5	98.5
H	81	81	96.5	98.5
J	99.5	99.5	115	117
K	99.5	99.5	115	117
L	105.5	105.5	121	123
M	105.5	105.5	121	123
P	134	134	149.5	151.5
Q	152.5	152.5	168	170
R	158.5	158.5	174	176
S	128.5	128.5	144	146
T	147	147	162.5	164.5
W	153	153	168.5	170.5

Manifold type		Weight (g)
Side block	VKM.....S1...	72.5
	VKM.....S2...	84
	VKM.....S3...	72.5
	VKM.....S.....	61
Manifold intermediate block	VKM-M.....(Without Plug)	20.5
	VKM-MP.....(With Plug)	22

Block plate	Weight (g)
VKM...-MB...	6

Silencer	Weight (g)
Silencer for stand-alone type	2

Cartridge for stand-alone type	Weight (g)
CJC09-04	3.5
CJC09-06	3.5
CJC09-08	10
CJC14-08	10
CJP09	1.5

Cartridge for manifold type	Weight (g)
CJC18-06	20.5
CJC18-08	20
CJC18-10	19
CJC18-12	26
CJC18-16	36.5
CJL18-08	25
CJL18-10	31.5
CJL18-12	37.5
CJF18-02	43.5
CJF18-03	34.5
CJF18-04	38
CJP18	6

■ Total weight can be calculated by the following calculation formula.

(Stand-alone/Manifold; combination x No. of stations) + (Vacuum port cartridge x qty) + (Supply port cartridge x qty) + (Exhaust port cartridge x qty) + Manifold type

Example1. VKA H 10 W - 06 08 S E - W - NA

- 153 + 3.5 + 10 + 2 = 168.5g
- Stand-alone weight: VKA / Combination (W): 153g
 - Vacuum port cartridge (CJC09-06): 3.5g
 - Supply port cartridge (CJC09-08): 10g
 - Exhaust port cartridge (Silencer for stand-alone type): 2g

Example2. VKM H 07 P - S6 28 72 E - W 02

- 299 + 7 + 40 + 49.5 + 61 = 456.5g
- Manifold weight: VKM...S...
Combination code: P,
No. of stations: 2 stations : 149.5 x 2 stations
 - Cartridge for vacuum port (CJC09-06): 3.5g x 2 pcs
 - Cartridge for supply port (CJC18-08): 20g x 2 pcs
 - Cartridge for exhaust port (CJF18-02 + CJP18): 43.5g + 6g
 - Manifold type (VKM...): 61g

Example3. Complicated combination of manifold type

VKM - 00 10 S2 - B 03 (Manifold type) ... ①
 VKM H 12 M - T6 00 00 E - B - NW (St.1) ... ②
 VKM L 07 Q - S8 00 00 G - B (St.2) ... ③
 VKM - MB PP - B (St.3) ... ④

109 + 126.5 + 178 + 28 = 441.5g

- Manifold type ("VKM...S..." + "Cartridge for supply port (CJC18-10)" + " Plug for supply port (CJP18)"): 84g + 19g + 6g
- Manifold type ("VKM...T..." , "Combination code (M)" + "Cartridge for vacuum port (CJC09-06)"): 123g + 3.5g
- Manifold type ("VKM...S..." , "Combination code (Q)" + "Cartridge for vacuum port (CJC09-08)"): 168g + 10g
- Manifold intermediate block with plug ("VKM-MP-" + "Block plate (VKM-MB)"): 22g + 6g



Vacuum Generator Series

Standard Size List

Unit combinations: Built-in filter

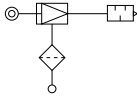

Type	Vacuum port	Air supply port						Exhaust port
		5/32in	1/4in	5/16in	4mm	6mm	8mm	
VKA VKE A Type	5/32in.	●	●	●	—	—	—	8mm With silencer
	1/4in.	●	●	●	—	—	—	8mm With silencer
	5/16in.	●	●	●	—	—	—	8mm With silencer
	4mm	—	—	—	●	●	●	8mm With silencer
	6mm	—	—	—	●	●	●	8mm With silencer
	8mm	—	—	—	●	●	●	8mm With silencer
	8mm	—	—	—	●	●	●	8mm With silencer

Unit combinations: Built-in filter and check valve

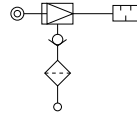

Type	Vacuum port	Air supply port						Exhaust port
		5/32in	1/4in	5/16in	4mm	6mm	8mm	
VKA VKE B Type	5/32in.	●	●	●	—	—	—	8mm With silencer
	1/4in.	●	●	●	—	—	—	8mm With silencer
	5/16in.	●	●	●	—	—	—	8mm With silencer
	4mm	—	—	—	●	●	●	8mm With silencer
	6mm	—	—	—	●	●	●	8mm With silencer
	8mm	—	—	—	●	●	●	8mm With silencer
	8mm	—	—	—	●	●	●	8mm With silencer

Unit combinations: Built-in filter and Mechanical vacuum switch

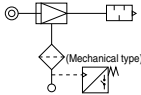

Type	Vacuum port	Air supply port						Exhaust port
		5/32in	1/4in	5/16in	4mm	6mm	8mm	
VKA VKE C Type	5/32in.	●	●	●	—	—	—	8mm With silencer
	1/4in.	●	●	●	—	—	—	8mm With silencer
	5/16in.	●	●	●	—	—	—	8mm With silencer
	4mm	—	—	—	●	●	●	8mm With silencer
	6mm	—	—	—	●	●	●	8mm With silencer
	8mm	—	—	—	●	●	●	8mm With silencer
	8mm	—	—	—	●	●	●	8mm With silencer

Unit combinations: Built-in filter, Check valve and Mechanical vacuum switch

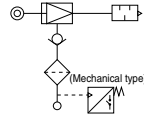

Type	Vacuum port	Air supply port						Exhaust port
		5/32in	1/4in	5/16in	4mm	6mm	8mm	
VKA VKE D Type	5/32in.	●	●	●	—	—	—	8mm With silencer
	1/4in.	●	●	●	—	—	—	8mm With silencer
	5/16in.	●	●	●	—	—	—	8mm With silencer
	4mm	—	—	—	●	●	●	8mm With silencer
	6mm	—	—	—	●	●	●	8mm With silencer
	8mm	—	—	—	●	●	●	8mm With silencer
	8mm	—	—	—	●	●	●	8mm With silencer

Unit combinations: Built-in filter and Digital vacuum switch with LED display

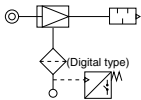

Type	Vacuum port	Air supply port						Exhaust port
		5/32in	1/4in	5/16in	4mm	6mm	8mm	
VKA VKE E Type	5/32in.	●	●	●	—	—	—	8mm With silencer
	1/4in.	●	●	●	—	—	—	8mm With silencer
	5/16in.	●	●	●	—	—	—	8mm With silencer
	4mm	—	—	—	●	●	●	8mm With silencer
	6mm	—	—	—	●	●	●	8mm With silencer
	8mm	—	—	—	●	●	●	8mm With silencer
	8mm	—	—	—	●	●	●	8mm With silencer

Unit combinations: Built-in filter, Check valve and Digital vacuum switch with LED display

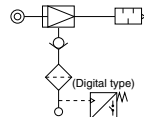

Type	Vacuum port	Air supply port						Exhaust port
		5/32in	1/4in	5/16in	4mm	6mm	8mm	
VKA VKE F Type	5/32in.	●	●	●	—	—	—	8mm With silencer
	1/4in.	●	●	●	—	—	—	8mm With silencer
	5/16in.	●	●	●	—	—	—	8mm With silencer
	4mm	—	—	—	●	●	●	8mm With silencer
	6mm	—	—	—	●	●	●	8mm With silencer
	8mm	—	—	—	●	●	●	8mm With silencer
	8mm	—	—	—	●	●	●	8mm With silencer

Unit combinations: Built-in filter and Suction solenoid valve

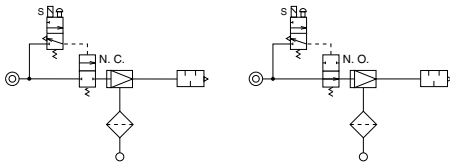

Unit combinations: Built-in filter, Check valve and Suction solenoid valve

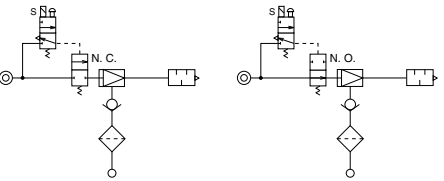

Type	Vacuum port	Air supply port						Exhaust port
		5/32in.	1/4in.	5/16in.	4mm	6mm	8mm	
VKA VKE G Type	5/32in.	●	●	●	—	—	—	8mm
	1/4in.	●	●	●	—	—	—	8mm
		●	●	●	—	—	—	8mm
	5/16in.	●	●	●	—	—	—	8mm
		●	●	●	—	—	—	With silencer
	4mm	—	—	—	●	●	●	8mm
		—	—	—	●	●	●	With silencer
6mm	—	—	—	●	●	●	8mm	
	—	—	—	●	●	●	With silencer	
8mm	—	—	—	●	●	●	8mm	
	—	—	—	●	●	●	With silencer	

Type	Vacuum port	Air supply port						Exhaust port
		5/32in.	1/4in.	5/16in.	4mm	6mm	8mm	
VKA VKE H Type	5/32in.	●	●	●	—	—	—	8mm
	1/4in.	●	●	●	—	—	—	8mm
		●	●	●	—	—	—	With silencer
	5/16in.	●	●	●	—	—	—	8mm
		●	●	●	—	—	—	With silencer
	4mm	—	—	—	●	●	●	8mm
		—	—	—	●	●	●	With silencer
6mm	—	—	—	●	●	●	8mm	
	—	—	—	●	●	●	With silencer	
8mm	—	—	—	●	●	●	8mm	
	—	—	—	●	●	●	With silencer	

Unit combinations: Built-in filter, Suction solenoid valve and Mechanical vacuum switch

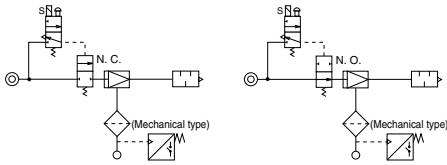

Unit combinations: Built-in filter, Check valve, Suction solenoid valve and Mechanical vacuum switch

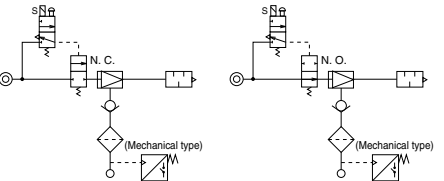

Type	Vacuum port	Air supply port						Exhaust port
		5/32in.	1/4in.	5/16in.	4mm	6mm	8mm	
VKA VKE J Type	5/32in.	●	●	●	—	—	—	8mm
	1/4in.	●	●	●	—	—	—	8mm
		●	●	●	—	—	—	With silencer
	5/16in.	●	●	●	—	—	—	8mm
		●	●	●	—	—	—	With silencer
	4mm	—	—	—	●	●	●	8mm
		—	—	—	●	●	●	With silencer
6mm	—	—	—	●	●	●	8mm	
	—	—	—	●	●	●	With silencer	
8mm	—	—	—	●	●	●	8mm	
	—	—	—	●	●	●	With silencer	

Type	Vacuum port	Air supply port						Exhaust port
		5/32in.	1/4in.	5/16in.	4mm	6mm	8mm	
VKA VKE K Type	5/32in.	●	●	●	—	—	—	8mm
	1/4in.	●	●	●	—	—	—	8mm
		●	●	●	—	—	—	With silencer
	5/16in.	●	●	●	—	—	—	8mm
		●	●	●	—	—	—	With silencer
	4mm	—	—	—	●	●	●	8mm
		—	—	—	●	●	●	With silencer
6mm	—	—	—	●	●	●	8mm	
	—	—	—	●	●	●	With silencer	
8mm	—	—	—	●	●	●	8mm	
	—	—	—	●	●	●	With silencer	

Standard Size List

Unit combinations: Built-in filter, Suction solenoid valve and Digital vacuum switch with LED display

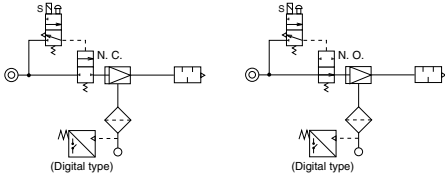

Unit combinations: Built-in filter, Check valve, Suction solenoid valve and Digital vacuum switch with LED display

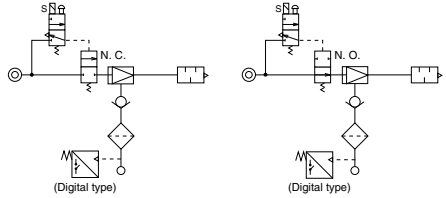

Type	Vacuum port	Air supply port						Exhaust port
		5/32in	1/4in	5/16in	4mm	6mm	8mm	
VKA VKB L Type	5/32in.	●	●	●	—	—	—	8mm With silencer
	1/4in.	●	●	●	—	—	—	8mm With silencer
	5/16in.	●	●	●	—	—	—	8mm With silencer
	4mm	—	—	—	●	●	●	8mm With silencer
	6mm	—	—	—	●	●	●	8mm With silencer
	8mm	—	—	—	●	●	●	8mm With silencer
						●	●	●

Type	Vacuum port	Air supply port						Exhaust port
		5/32in	1/4in	5/16in	4mm	6mm	8mm	
VKA VKB M Type	5/32in.	●	●	●	—	—	—	8mm With silencer
	1/4in.	●	●	●	—	—	—	8mm With silencer
	5/16in.	●	●	●	—	—	—	8mm With silencer
	4mm	—	—	—	●	●	●	8mm With silencer
	6mm	—	—	—	●	●	●	8mm With silencer
	8mm	—	—	—	●	●	●	8mm With silencer
						●	●	●

Unit combinations: Built-in filter, Suction solenoid valve and Air timer type blow-off valve

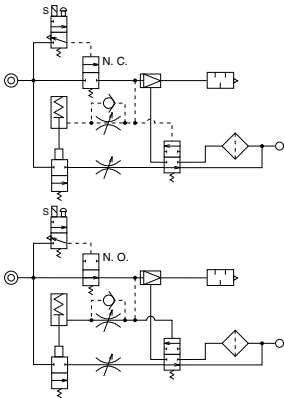

Unit combinations: Built-in filter, Suction solenoid valve, Mechanical vacuum switch and Air timer type blow-off valve

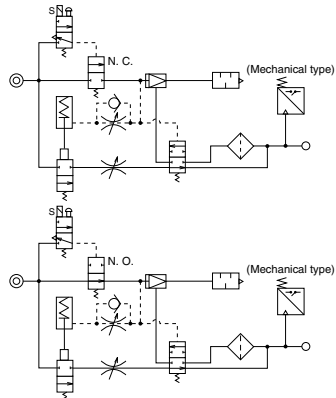

Type	Vacuum port	Air supply port						Exhaust port
		5/32in	1/4in	5/16in	4mm	6mm	8mm	
VKA VKB P Type	5/32in.	●	●	●	—	—	—	8mm With silencer
	1/4in.	●	●	●	—	—	—	8mm With silencer
	5/16in.	●	●	●	—	—	—	8mm With silencer
	4mm	—	—	—	●	●	●	8mm With silencer
	6mm	—	—	—	●	●	●	8mm With silencer
	8mm	—	—	—	●	●	●	8mm With silencer
						●	●	●

Type	Vacuum port	Air supply port						Exhaust port
		5/32in	1/4in	5/16in	4mm	6mm	8mm	
VKA VKB G Type	5/32in.	●	●	●	—	—	—	8mm With silencer
	1/4in.	●	●	●	—	—	—	8mm With silencer
	5/16in.	●	●	●	—	—	—	8mm With silencer
	4mm	—	—	—	●	●	●	8mm With silencer
	6mm	—	—	—	●	●	●	8mm With silencer
	8mm	—	—	—	●	●	●	8mm With silencer
						●	●	●

Unit combinations: Built-in filter, Suction solenoid valve, Digital vacuum switch with LED display and Air timer type blow-off valve

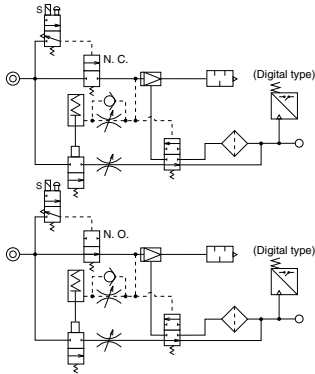

Unit combinations: Built-in filter, Suction solenoid valve and Blow-off solenoid valve

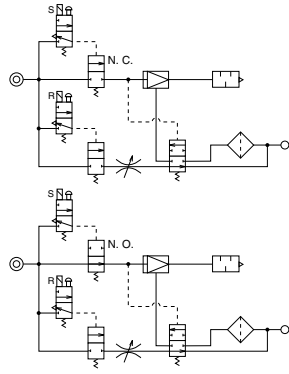

Type	Vacuum port	Air supply port						Exhaust port
		5/32in	1/4in	5/16in	4mm	6mm	8mm	
VKA VKE R Type	5/32in.	●	●	●	—	—	—	8mm With silencer
	1/4in.	●	●	●	—	—	—	8mm With silencer
	5/16in.	●	●	●	—	—	—	8mm With silencer
	4mm	—	—	—	●	●	●	8mm With silencer
	6mm	—	—	—	●	●	●	8mm With silencer
	8mm	—	—	—	●	●	●	8mm With silencer
	8mm	—	—	—	●	●	●	8mm With silencer

Type	Vacuum port	Air supply port						Exhaust port
		5/32in	1/4in	5/16in	4mm	6mm	8mm	
VKA VKE S Type	5/32in.	●	●	●	—	—	—	8mm With silencer
	1/4in.	●	●	●	—	—	—	8mm With silencer
	5/16in.	●	●	●	—	—	—	8mm With silencer
	4mm	—	—	—	●	●	●	8mm With silencer
	6mm	—	—	—	●	●	●	8mm With silencer
	8mm	—	—	—	●	●	●	8mm With silencer
	8mm	—	—	—	●	●	●	8mm With silencer

Unit combinations: Built-in filter, Suction solenoid valve, Mechanical vacuum switch and Blow-off solenoid valve

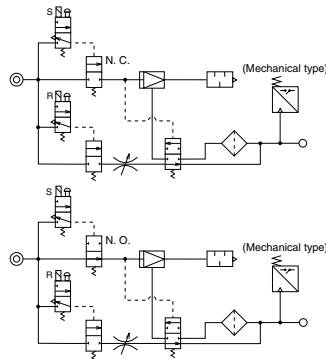

Unit combinations: Built-in filter, Suction solenoid valve, Digital vacuum switch with LED display and Blow-off solenoid valve

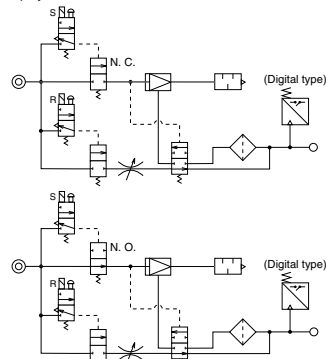

Type	Vacuum port	Air supply port						Exhaust port
		5/32in	1/4in	5/16in	4mm	6mm	8mm	
VKA VKE T Type	5/32in.	●	●	●	—	—	—	8mm With silencer
	1/4in.	●	●	●	—	—	—	8mm With silencer
	5/16in.	●	●	●	—	—	—	8mm With silencer
	4mm	—	—	—	●	●	●	8mm With silencer
	6mm	—	—	—	●	●	●	8mm With silencer
	8mm	—	—	—	●	●	●	8mm With silencer
	8mm	—	—	—	●	●	●	8mm With silencer

Type	Vacuum port	Air supply port						Exhaust port
		5/32in	1/4in	5/16in	4mm	6mm	8mm	
VKA VKE W Type	5/32in.	●	●	●	—	—	—	8mm With silencer
	1/4in.	●	●	●	—	—	—	8mm With silencer
	5/16in.	●	●	●	—	—	—	8mm With silencer
	4mm	—	—	—	●	●	●	8mm With silencer
	6mm	—	—	—	●	●	●	8mm With silencer
	8mm	—	—	—	●	●	●	8mm With silencer
	8mm	—	—	—	●	●	●	8mm With silencer

Vacuum Generator Series



Model code

VKA□□□A.....
VKA□□□B.....

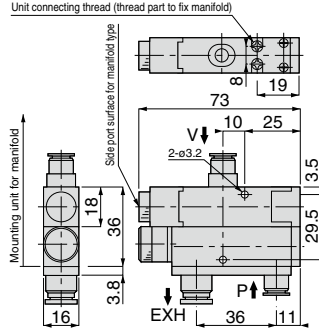

Circuit diagram

VKA□□□A.....
(Combination code: A type, Vacuum generator and Filter.)

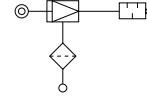

VKA□□□B.....
(Combination code: B type, Vacuum generator, Filter and Check valve.)

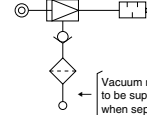

Model code

VKA□□□C.....
VKA□□□D.....

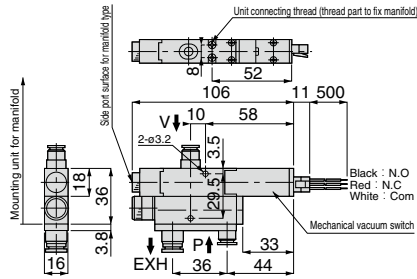

Circuit diagram

VKA□□□C.....
(Combination code: C type, Vacuum generator, Filter and Mechanical vacuum switch.)

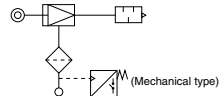

VKA□□□D.....
(Combination code: D type, Vacuum generator, Filter, Check valve, Mechanical vacuum switch.)

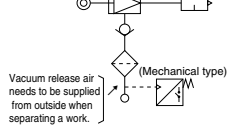

Model code

VKA□□□E.....
VKA□□□F.....

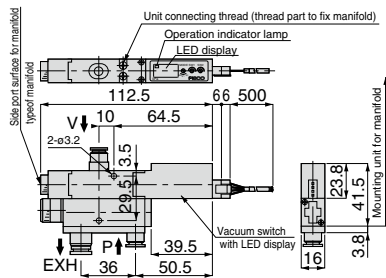

Circuit diagram

VKA□□□E.....
(Combination code: E type, Vacuum generator, Filter and Vacuum switch with LED display.)

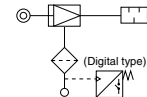

VKA□□□F.....
(Combination code: F type, Vacuum generator, Filter, Check valve, Vacuum switch with LED display.)

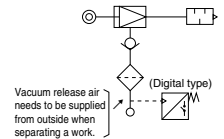

Vacuum Generator Series

Vacuum Generator VK

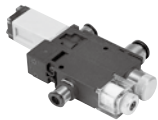

Model code

VKA□□□G.....

VKA□□□H.....

Unit connecting thread
(thread part to fix manifold)

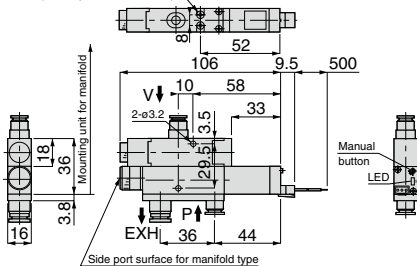

Circuit diagram

VKA□□□G.....E or F
(Combination code: G type, Vacuum generator (N.C.), Suction solenoid valve and Filter.)

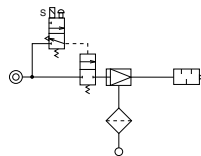

VKA□□□G.....G or H
(Combination code: G type, Vacuum generator, (N.O.) Suction solenoid valve and Filter.)

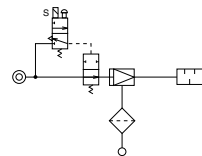

VKA□□□H.....E or F
(Combination code: H type, Vacuum generator (N.C.), Suction solenoid valve, Filter and Check valve.)

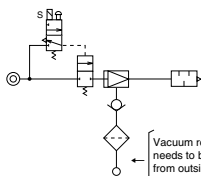

VKA□□□H.....G or H
(Combination code: H type, Vacuum generator (N.O.), Suction solenoid valve, Filter and Check valve.)

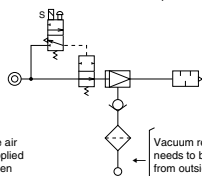

Model code

VKA□□□J.....

VKA□□□K.....

Unit connecting thread
(thread part to fix manifold)

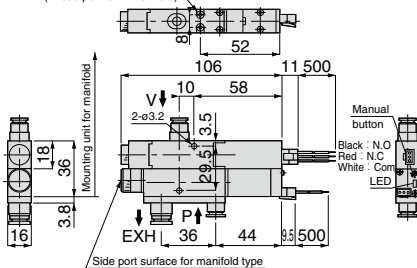

Circuit diagram

VKA□□□J.....E or F
(Combination code: J type, Vacuum generator (N.C.), Suction solenoid valve, Filter and Mechanical vacuum switch.)

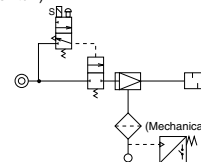

VKA□□□J.....G or H
(Combination code: J type, Vacuum generator (N.O.), Suction solenoid valve, Filter and Mechanical vacuum switch.)

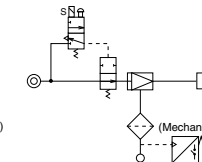

VKA□□□K.....E or F
(Combination code: K type, Vacuum generator (N.C.), Suction solenoid valve, Filter, Check valve and Mechanical vacuum switch.)

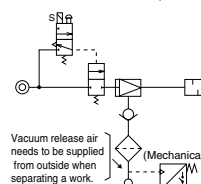

VKA□□□K.....G or H
(Combination code: K type, Vacuum generator (N.O.), Suction solenoid valve, Filter, Check valve and Mechanical vacuum switch.)

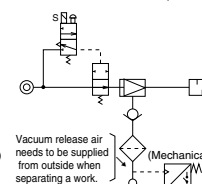



Model code
VKA□□□L.....
VKA□□□M.....

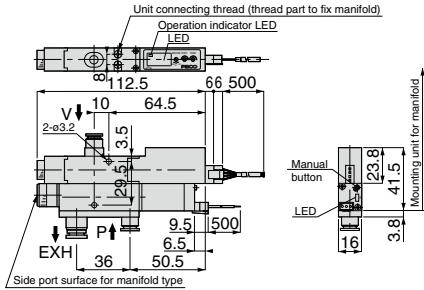

Circuit diagram

VKA□□□L.....E or F
(Combination code: L type, Vacuum generator (N.C.), Suction solenoid valve, Filter and Vacuum switch with LED display.)

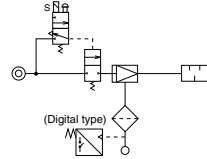

VKA□□□L.....G or H
(Combination code: L type, Vacuum generator (N.C.), Suction solenoid valve, Filter and Vacuum switch with LED display.)

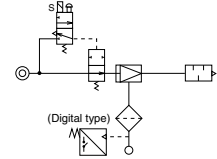

VKA□□□M.....E or F
(Combination code: M type, Vacuum generator (N.C.), Suction solenoid valve, Filter, Check valve and Vacuum switch with LED display.)

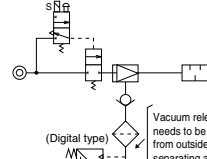

VKA□□□M.....G or H
(Combination code: M type, vacuum generator (N.O.), Suction solenoid valve, Filter, Check valve and Vacuum switch with LED display.)

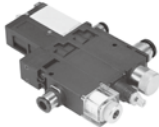
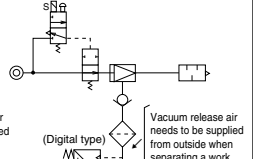

Model code
VKA□□□P.....

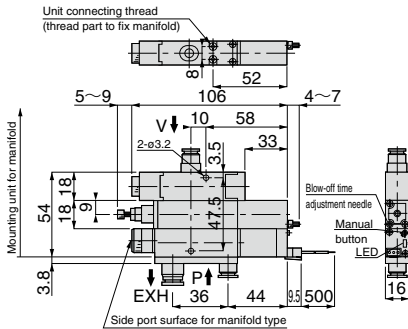

Circuit diagram

VKA□□□P.....E or F
(Combination code: P type, Vacuum generator (N.C.), Suction solenoid valve, Air timer type blow-off valve and Filter.)

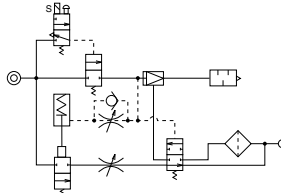

VKA□□□P.....G or H
(Combination code: P type, Vacuum generator (N.O.), Suction solenoid valve, Air timer type blow-off valve and Filter.)

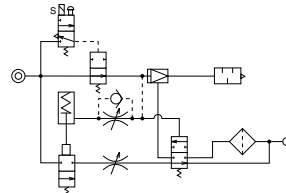

Vacuum Generator Series

Vacuum Generator VK

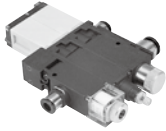

Model code

VKA□□□S.....

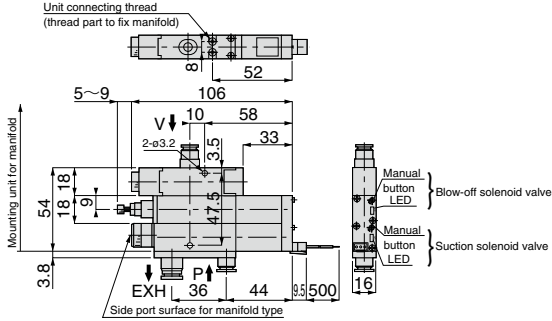

Circuit diagram

VKA□□□S.....E or F

(Combination code: S type, Vacuum generator (N.C.), Suction solenoid valve, Blow-off suction valve and Filter.)

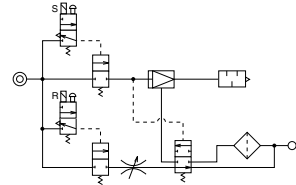

VKA□□□S.....G or H

(Combination code: S type, Vacuum generator (N.O.), Suction solenoid valve, Blow-off suction valve and Filter.)

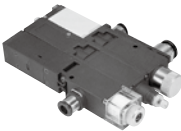
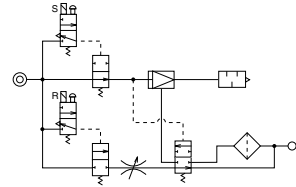

Model code

VKA□□□Q.....

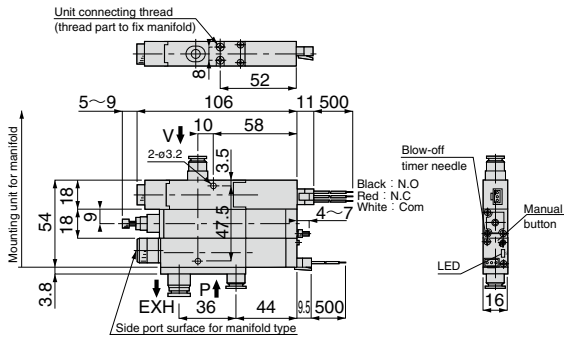

Circuit diagram

VKA□□□Q.....E or F

(Combination code: Q type, Vacuum generator (N.C.), Suction solenoid valve, Air timer type blow-off valve, Filter and Mechanical vacuum switch.)

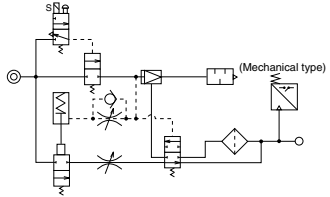

VKA□□□Q.....G or H

(Combination code: Q type, Vacuum generator (N.O.), Suction solenoid valve, Air timer type blow-off valve, Filter and Mechanical vacuum switch.)

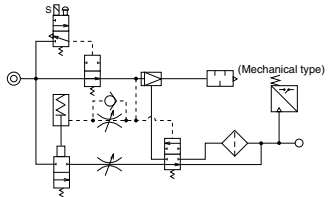

Vacuum Generator Series

Vacuum Generator VK

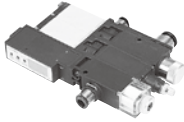

Model code

VKA□□□W.....

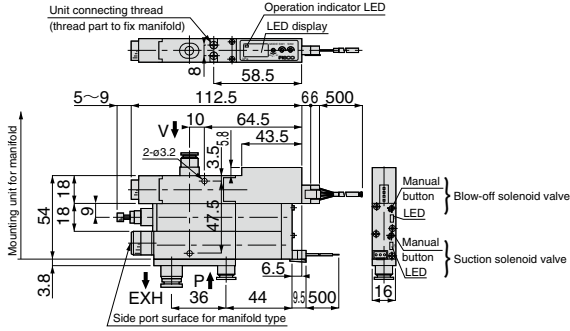

Circuit diagram

VKA□□□W.....E or F
(Combination code: W type, Vacuum generator (N.C.), Suction solenoid valve, Blow-off suction valve, Filter and vacuum switch with LED display.)

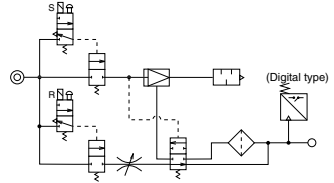

VKA□□□W.....G or H
(Combination code: W type, Vacuum generator (N.O.), Suction solenoid valve, Blow-off suction valve, Filter and Vacuum switch with LED display.)

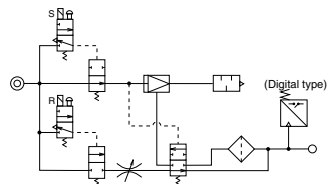

Dimension of Fitting Part

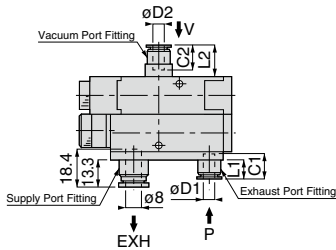

Unit : mm

	Tube O.D. φD1	Tube O.D. φD2	L1	L2	C1	C2
P Port	4(5/32)	-	6	-	11	-
	6(1/4)	-	9	-	12	-
	8(5/16)	-	17.5	-	18.5	-
V Port	-	4(5/32)	-	11.5	-	11
	-	6(1/4)	-	14.5	-	12
-	-	8(5/16)	-	23	-	18.5

VKA / VKB common silencer (Exhaust)

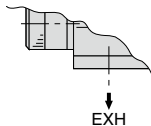

VKA / VKB common Exhaust Fitting (Elbow)

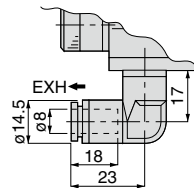



Model code

VKB □□□ A.....
 VKB □□□ B.....

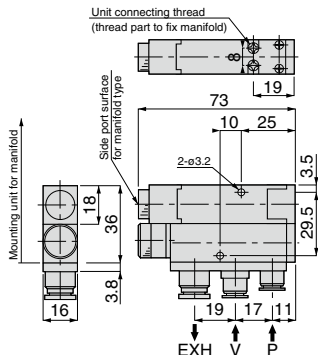

Circuit diagram

VKB□□□A.....
 (Combination code: A type, Vacuum generator and Filter.)

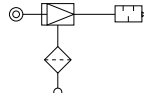

VKB□□□B.....
 (Combination code: B type, Vacuum generator, Filter and Check valve.)

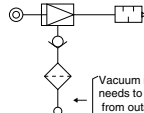

Model code

VKB □□□ C.....
 VKB □□□ D.....

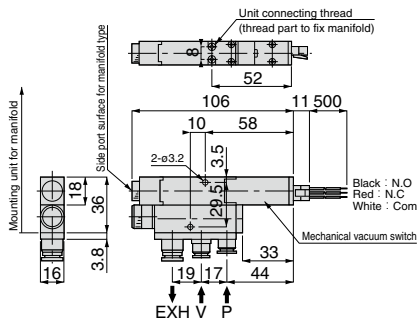

Circuit diagram

VKB□□□C.....
 (Combination code: C type, Vacuum generator, Filter and Mechanical vacuum switch.)

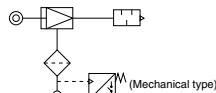

VKB□□□D.....
 (Combination code: D type, Vacuum generator, Filter, Check valve, Mechanical vacuum switch.)

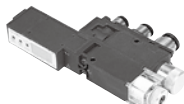
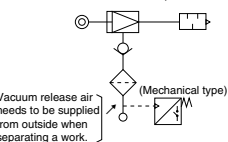

Model code

VKB □□□ E.....
 VKB □□□ F.....

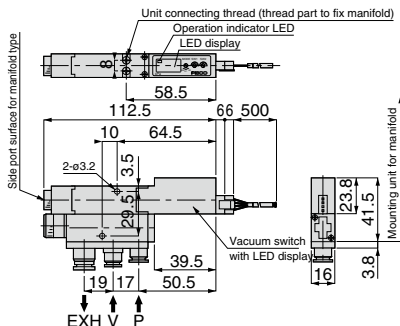

Circuit diagram

VKB□□□E.....
 (Combination code: E type, Vacuum generator, Filter and Vacuum switch with LED display.)

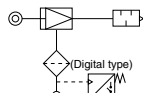

VKB□□□F.....
 (Combination code: F type, Vacuum generator, Filter, Check valve, Vacuum switch with LED display.)

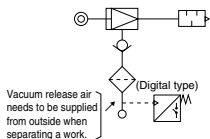

Vacuum Generator Series

Vacuum Generator VK

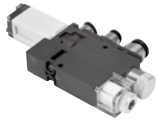

Model code

VKB□□□G.....
VKB□□□H.....

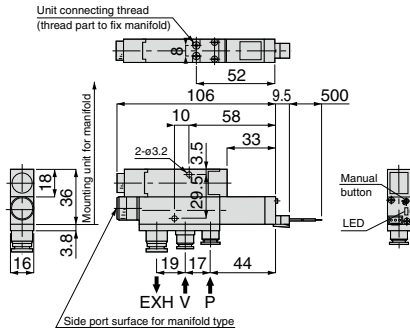

Circuit diagram

VKB□□□G.....E or F
(Combination code: G type, Vacuum generator (N.C.), Suction solenoid valve and Filter.)

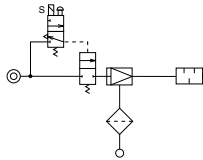

VKB□□□G.....G or H
(Combination code: G type, Vacuum generator, (N.O.) Suction solenoid valve and Filter.)

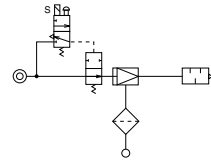

VKB□□□H.....E or F
(Combination code: H type, Vacuum generator (N.C.), Suction solenoid valve, Filter and Check valve.)

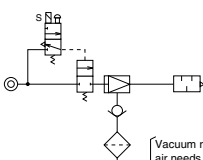

VKB□□□H.....G or H
(Combination code: H type, Vacuum generator (N.O.), Suction solenoid valve, Filter and Check valve.)

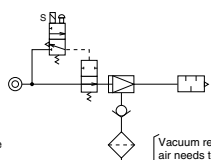

Vacuum release air needs to be supplied from outside when separating a work.

Vacuum release air needs to be supplied from outside when separating a work.

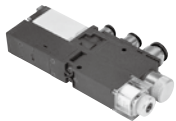

Model code

VKB□□□J.....
VKB□□□K.....

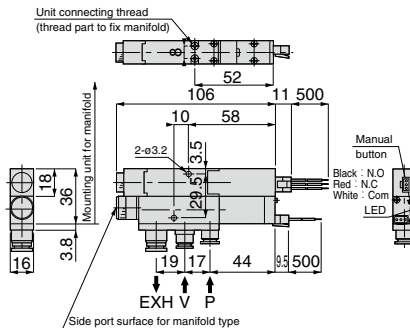

Circuit diagram

VKB□□□J.....E or F
(Combination code: J type, Vacuum generator (N.C.), Suction solenoid valve, Filter and Mechanical vacuum switch.)

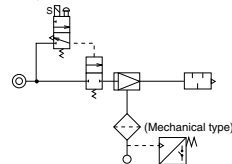

VKB□□□J.....G or H
(Combination code: J type, Vacuum generator (N.O.), Suction solenoid valve, Filter and Mechanical vacuum switch.)

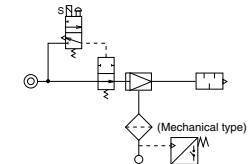

VKB□□□K.....E or F
(Combination code: K type, Vacuum generator (N.C.), Suction solenoid valve, Filter, Check valve and Mechanical vacuum switch.)

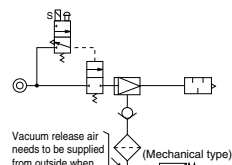

VKB□□□K.....G or H
(Combination code: K type, Vacuum generator (N.O.), Suction solenoid valve, Filter, Check valve and Mechanical vacuum switch.)

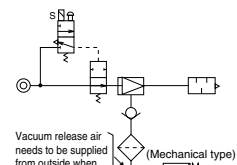

Vacuum release air needs to be supplied from outside when separating a work.

Vacuum release air needs to be supplied from outside when separating a work.

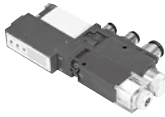

Model code
VKB□□□L.....
VKB□□□M.....

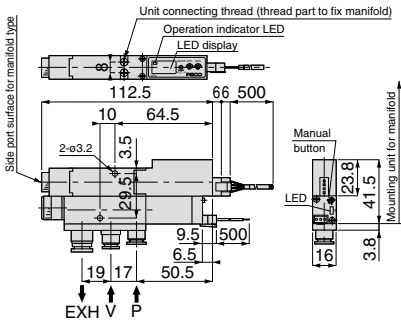

Circuit diagram

VKB□□□L.....E or F

(Combination code: L type, Vacuum generator (N.C.), Suction solenoid valve, Filter and Vacuum switch with LED display.)

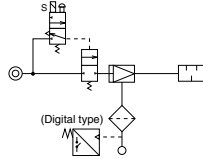

VKB□□□L.....G or H

(Combination code: L type, Vacuum generator (N.O.), Suction solenoid valve, Filter and Vacuum switch with LED display.)

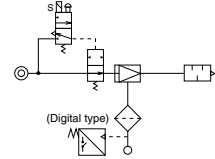

VKB□□□M.....E or F

(Combination code: M type, Vacuum generator (N.C.), Suction solenoid valve, Filter, Check valve and Vacuum switch with LED display.)

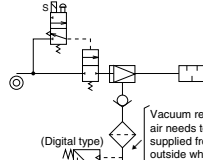

VKB□□□M.....G or H

(Combination code: M type, Vacuum generator (N.O.), Suction solenoid valve, Filter, Check valve and Vacuum switch with LED display.)

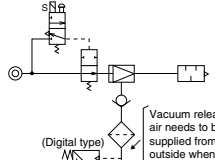

Vacuum release air needs to be supplied from outside when separating a work.

Vacuum release air needs to be supplied from outside when separating a work.

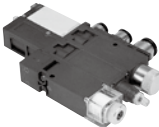

Model code
VKB□□□P.....

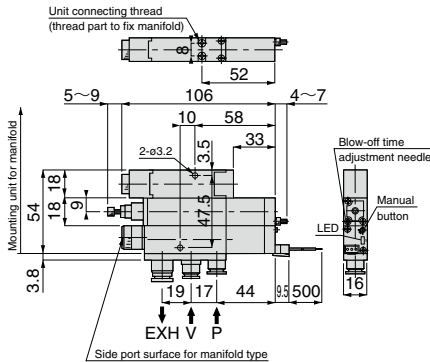

Circuit diagram

VKB□□□P.....E or F

(Combination code: P type, Vacuum generator (N.C.), Suction solenoid valve, Air timer type blow-off valve and Filter.)

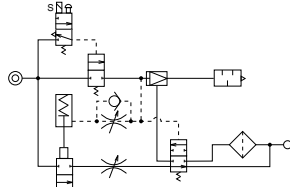

VKB□□□P.....G or H

(Combination code: P type, Vacuum generator (N.O.), Suction solenoid valve, Air timer type blow-off valve and Filter.)

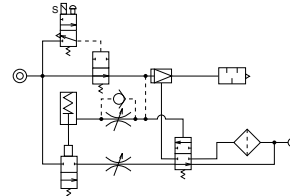

Vacuum Generator Series

Vacuum Generator VK



Model code

VKB□□□S.....

Unit connecting thread
(thread part to fix manifold)

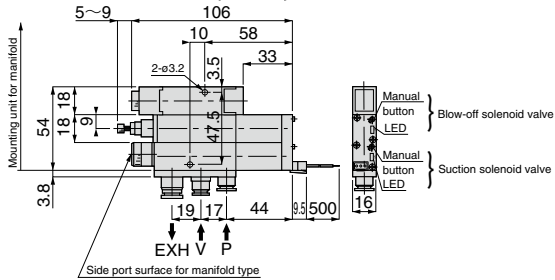

Circuit diagram

VKB□□□S.....E or F

(Combination code: S type, Vacuum generator (N.C.), Suction solenoid valve, Blow-off suction valve and Filter.)

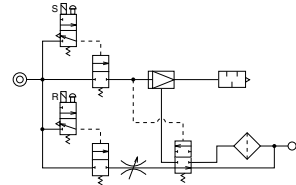

VKB□□□S.....G or H

(Combination code: S type, Vacuum generator (N.O.), Suction solenoid valve, Blow-off suction valve and Filter.)

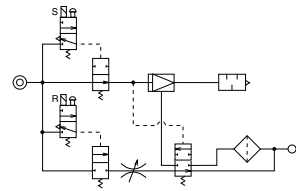

Model code

VKB□□□Q.....

Unit connecting thread
(thread part to fix manifold)

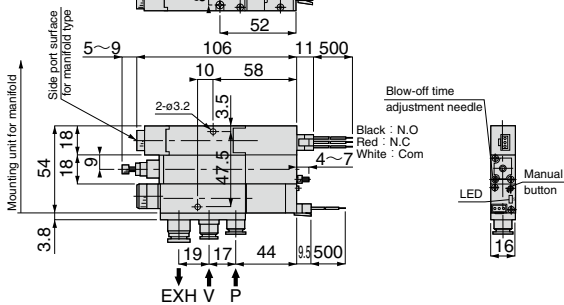
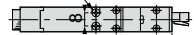

Circuit diagram

VKB□□□Q.....E or F

(Combination code: Q type, Vacuum generator (N.C.), Suction solenoid valve, Air timer type blow-off valve, Filter and Mechanical vacuum switch.)

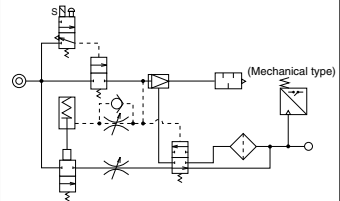

VKB□□□Q.....G or H

(Combination code: Q, vacuum generator (N.O.), Suction solenoid valve, air timer type blow-off valve, filter and Mechanical vacuum switch.)

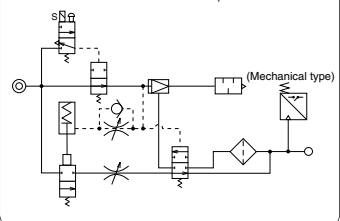

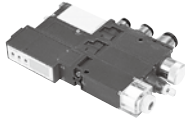

Model code
VKB□□□R.....

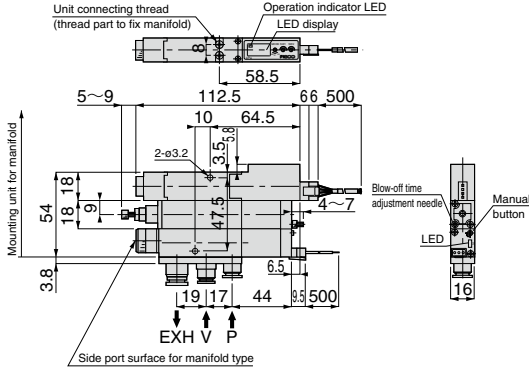

Circuit diagram

VKB□□□R.....E or F
(Combination code: R type, Vacuum generator (N.C.), Suction solenoid valve, Filter and Vacuum switch with LED display.)

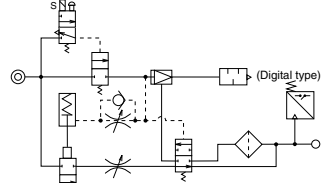

VKB□□□R.....G or H
(Combination code: R type, Vacuum generator (N.O.), Suction solenoid valve, Air timer type blow-off valve, Filter and Vacuum switch with LED display.)

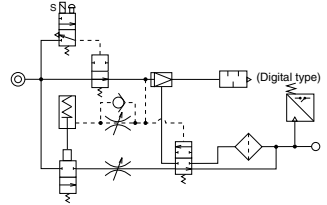

Model code
VKB□□□T.....

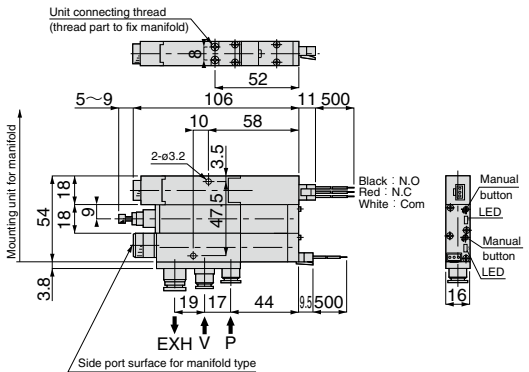

Circuit diagram

VKB□□□T.....E or F
(Combination code: T type, Vacuum generator (N.C.), Suction solenoid valve, Blow-off suction valve, Filter and Mechanical vacuum switch.)

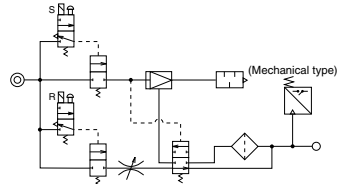

VKB□□□T.....G or H
(Combination code: T type, Vacuum generator (N.O.), Suction solenoid valve, Blow-off suction valve, Filter and Mechanical vacuum switch.)

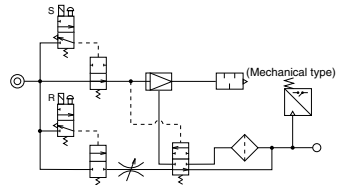

Vacuum Generator Series

Vacuum Generator VK

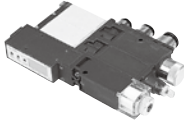

Model code

VKB□□□W□□□□

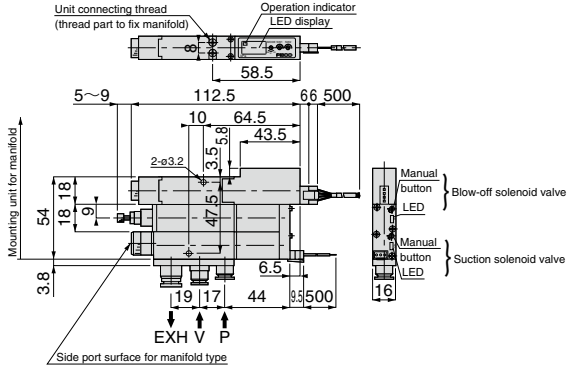

Circuit diagram

VKB□□□W.....E or F
(Combination code: W type, Vacuum generator (N.C.), Suction solenoid valve, Blow-off suction valve, Filter and Vacuum switch with LED display.)

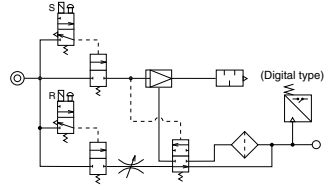

VKB□□□W.....G or H
(Combination code: W type, Vacuum generator (N.O.), Suction solenoid valve, Blow-off suction valve, Filter and Vacuum switch with LED display.)

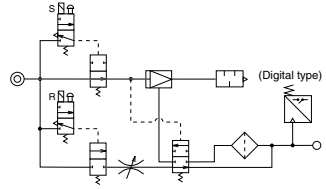

Dimension of Fitting Part

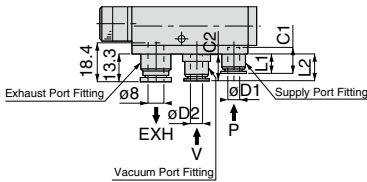

Unit : mm

	Tube O.D. $\phi D1$	Tube O.D. $\phi D2$	L1	L2	C1	C2
P Port	4(5/32)	-	6	-	11	-
	6(1/4)	-	9	-	12	-
	8(5/16)	-	17.5	-	18.5	-
V Port	-	4(5/32)	-	9.5	-	11
	-	6(1/4)	-	12.5	-	12
	-	8(5/16)	-	21	-	18.5

VKA / VKB common silencer (Exhaust)

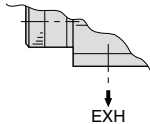

VKA / VKB common Exhaust Fitting (Elbow)

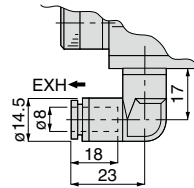

Dimension of Vacuum Port Fitting Part

Straight type

Plug cap type

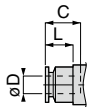

Unit : mm

Tube O.D. øD	L	C
4(5/32)	6	11
6(1/4)	9(16)	12(17)
8(5/16)	17.5	18.5



Dimension of Exhaust Port Fitting Part

Straight

Elbow

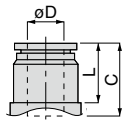

Unit : mm

Tube O.D. øD	L	C
8(5/16)	12	18
10(3/8)	14	20
12(1/2)	19	23.5
16(5/8)	23.5	24.5

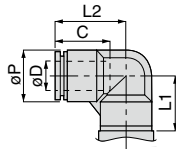

Unit : mm

Tube O.D. øD	øP	C	L1	L2
8(5/16)	14.5	18	17	23
10(3/8)	17.5	20	21	26.5
12(1/2)	21	23.5	23	29.5

Plug cap type

Female thread

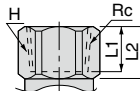

Unit : mm

Rc	Hex. H	L1	L2
Rc1/4(1/4NPT)	22	10	14
Rc3/8(3/8NPT)	22	10	14
Rc1/2(1/2NPT)	24	13	17

⚠ Detailed Safety Instructions

Before using PISCO products, be sure to read "Safety Instructions" and "Safety Instruction Manual", "Common Safety Instructions for Vacuum Series" and "Common Safety Instructions for Vacuum Generator VG & VK".

Warning

- A cartridge fitting and a silencer element are detachable for maintenance by pulling a lock pin. Make sure that the pin is properly inserted after the maintenance.
- The coil in a pilot solenoid valve generates heat under the following ① to ③ conditions. The heat may cause dropping life cycle, malfunctions, getting burnt or damaging peripheral machines.
Contact us when the power is applied to the vacuum generator under the following conditions:
 - ① The power is continuously ON for over 2 hours.
 - ② High-cycle operation.
 - ③ Even when intermittent running of the generator is carried out, the total operation time per day is longer than non-operation time.
- When the electricity is applied to valves for a long time, the coils generate a heat. The heat may cause dropping life cycle, malfunctions, getting burnt or damaging peripheral machines.

Caution

- In case that not all units generate vacuum at same time, the exhaust air of operating unit flows into the vacuum port of non-operating unit. If such exhaust air causes the problem, please consult with PISCO.

Safety Rules for Use

- Operating temperature range is 5-50°C . Do not operate the product out of the temperature range.
- Compressed air contains many kinds of drains such as water, oxidized oil, tar and other foreign substances. Dehumidify and improve the quality of air by using an after-cooler or a dryer, since those drains seriously impair the performance of the vacuum generator.
- Do not use lubricators.
- Rusts in the pipes may cause malfunction. Place a filter with finer than 5µm ahead of the air supply port.
- Avoid using the vacuum generator under the condition of corrosive gas or inflammable gas. Also do not use these gasses as a fluid.
- Avoid sucking dusts, salt and iron powder as much as possible.
- Do not operate Blow-off solenoid valve during a vacuum generation.
- After adjusting the air rate and turn the locknut until it stops at the needle guide, additionally tighten the locknut at 20-30° with a proper tool such as a pair of long-nose pliers. When this additional tightening is not done, the locknut maybe loosened and result in damaging the needle and the thread part of the locknut. Too much tightening may cause damage such as scraping off the knurling surface or a deformation of female thread.

1. Safety Rules for Manifold Type

- There is a possibility of a performance drop or a trouble by increasing mounting unit numbers on manifold type due to the following reasons. Consult us for the solutions.

1. A drop of the vacuum performance due to insufficient supply air.

Countermeasures: ① Check the supplied air volume.

② Arrange the piping length as short as possible.

③ Use Fittings with larger size.

④ Use both R and L side ports for the supply pressure when the supply is from one side only.

2. When there is a drop of the vacuum performance due to insufficient volume of exhaust port, or is an exhaust air leaking out through the vacuum port.

→ Consult us for the solutions. There is a limit of station numbers to maintain the manifold performance by a nozzle size or a vacuum performance of each mounting unit.

Reason (Silencer vent): A drop of the vacuum performance due to a large exhaust resistance caused by insufficient volume of silencer exhaust.

Countermeasures: ① Use silencers on both exhaust ports when a silencer is on one side.

② Set an external silencer (Special order)

③ Exhaust individually from each mounting unit. (Special order)

④ Avoid any obstacles around the exhaust ports.

⑤ Reduce number of mounting units.

Reason (Tube exhaust): A drop of the vacuum performance is caused by large pipe resistance.

Countermeasures: ① Use both exhaust ports when exhaust ports is on one side.

② Arrange the piping length as short as possible.

③ Use Fittings with larger size.

④ Exhaust individually from each mounting unit. (Special order)

⑤ Reduce number of mounting units.

2. LED Digital Vacuum Pressure Sensor (Vacuum Switch)

(1) Pressure Setting Method

① Turn on the power (Make sure the correct wiring and apply DC power to the vacuum pressure sensor).

②-1 Set the indicator switch at Pressure Setting Mode (ME → S1 / S2 and SW)

②-2 (Vacuum switch with analog output)

Fully turn the hysteresis setting trimmer (HYS) in the counterclockwise direction in order to minimize the hysteresis adjustment in advance.

③ Adjust the pressure adjusting trimmer (S1 / S2 and SW) with a flathead screwdriver to set at the desired value.

④ Set the indicator switch at ME and apply pressure and check the actual operation.

(Vacuum switch with 2 switch output)

Switch output 1 (S1): Red LED turns ON at the pressure with more than the setting.

Switch output 2 (S2): Green LED turns ON at the pressure with more than the setting.

(Vacuum switch with analog output)

Switch output (SW): Red LED turns ON at the pressure with more than the setting.

(2) Differential response setting

① Differential response setting can be adjusted by the hysteresis setting trimmer (HYS).

② Differential response setting range is regulated within about 0-15% of the set value. Differential response setting becomes large when the trimmer is turned in the clockwise direction.

③ Differential response setting adjustment

Set the indicator switch at ME (pressure indication mode). Increase or decrease the supply pressure gradually around the set pressure value and read the value at ON/OFF of the switch LED. Differences in displayed values are taken as differential response.

④ Hysteresis adjustment is useful for the following cases:

- Increase differential response when pressure pulsates with output repeatedly showing small on/off movements.
- When an allowable range is to be set for the lowering of pressure.

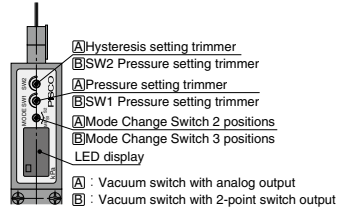

(3) Wire Connecting Method

NPN open collector / 2 switch output

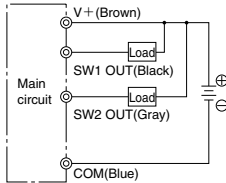

NPN open collector / 1 switch output and 1 analog output

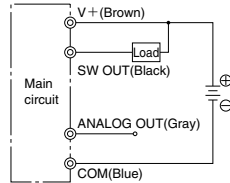

PNP open collector / 2 switch output

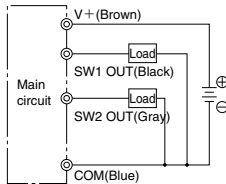

PNP open collector / 1 switch output and 1 analog output

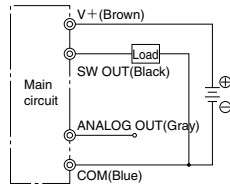

3. Safety Instructions for LED Digital Vacuum Pressure Sensor

- ① Do not use the vacuum switch in the environment or gasses containing corrosive substance. It may cause a sensor trouble.
- ② Wiring or ways by which noise or other disturbance is caused may cause a sensor trouble.
- ③ Since the sensors are not explosive-proof, do not use them in an inflammable or explosive gas, fluid or atmosphere.
- ④ Since the sensors are not drip / dust proof, do not use them in locations where they may be exposed to water or oil drops or dust.
- ⑤ Do not use the sensor in an atmosphere exceeding the range of application temperature or causing heat as sensor malfunction may result.
- ⑥ Make sure to turn off the power before wiring. Check the wire colors, and do not short-circuit output terminals, power supply terminals and COM terminals when wiring. Short-circuits may cause a sensor trouble.
- ⑦ Do not give an excessive tensile strength and bending on a lead wire. Otherwise, breaking wire or damage on connector may be caused.
- ⑧ Do not keep applying 0.2MPa or more of positive pressure to the vacuum pressure sensor constantly during a blow-off air supply. Otherwise, damaging to the sensor may be caused.
- ⑨ When adjusting pressure and differential response, use a flathead screwdriver (accessory). Do not apply an excessive force on the trimmer and slowly turn it within its rotation limits. Otherwise, there is a risk of damaging the trimmer and the circuit board.
- ⑩ Supply a stable DC power to the product.

- ⑪ Add a surge absorption circuit to relays or solenoid valves, etc. which are to be connected with output terminal and source terminal. Avoid any use which involves over 80mA in current.
- ⑫ Ground the FG terminal when using a unit power source such as switching current.
- ⑬ Output terminals (black with a gray lead wire) and other terminals should not be short-circuited.
- ⑭ Avoid strong external impacts and excessive force to the sensor body.

4. Mechanical vacuum switch

■ Vacuum switch of VK Series is a connector (detachable) type. Refer to the following figure for connecting method.

■ When adjusting the pressure setting, open the cover with a flathead screwdriver. Hold the cover with fingers to prevent the cover jumping out. Turn the adjusting nut in the clockwise direction to increase the vacuum pressure. The adjusting nut is fixed to the locknut, thus loosen the locknut first then adjust the pressure setting with the adjusting nut. After adjusting the pressure setting, hold the adjusting nut with fingers to fix it and tighten the locknut.

※ In case of a breakdown, contact us for repairing.

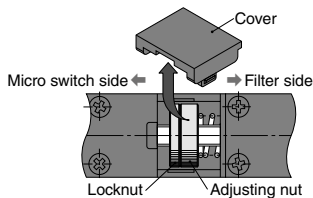

Lead wire color	
White	Common
Red	N.C.
Black	N.O.

5. Safety Rules for Mechanical vacuum switch & Vacuum Switch with LED display

■ When VK Series with vacuum switch is used, arrange tubes as short as possible.

■ When a piping is long, it creates large piping resistance which can cause malfunction such as the vacuum level around the sensor remains high even in no suction state. When a piping needs to be long unavoidably, place a sensor unit close to the vacuum end such as a vacuum pad.

6. Adjusting Method of Blow-off Air

■ Blow-off air (Blow-off solenoid valve / Air timer type blow-off valve)

· Turn the blow-off air rate adjustment needle to the right (clockwise) to reduce blow-off air and to the left (counterclockwise) to increase. ※ When finishing adjusting an air rate, make sure to tighten the locknut in order to avoid deviation from the setting. Read closely the following ① and ② for the tightening method.

① After adjusting the air rate and turn the locknut until it touches the needle guide, tighten the locknut additionally at 20-30° with a pair of long-nose pliers.

② Please be aware that too much tightening may cause damage like scraping off the knurling surface or a deformation of needle.

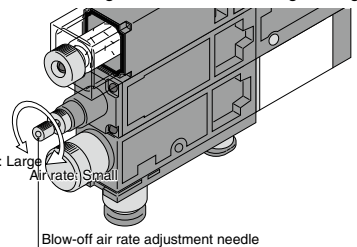

■ Time adjustment of air timer type blow-off valve

· Turn the blow-off timer needle to the right for a longer blow-off time and to the left for a shorter one.

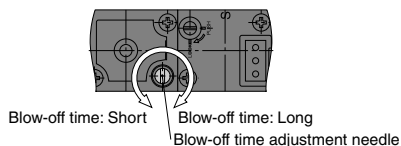

How to replace silencer elements of Stand-alone Type

Remove the fixing screw to replace the filter element. Make sure to place the filter seal rubber properly and tighten the screw to fix the filter cover with 0.3-0.5Nm of the tightening torque after the replacement.

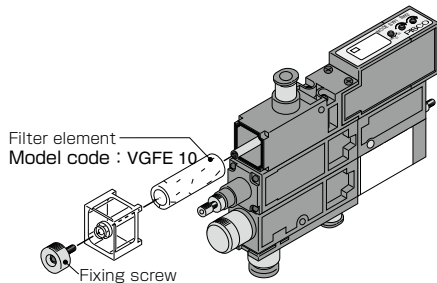

Use a flathead screwdriver to pull out the fixing pin in order to replace silencer elements. Make sure to insert the pin properly after the replacement. The fixing pin is bent for fall-proof. Insert the pin in the direction that the bent side of pin faces inward (filter side) as shown in the picture.

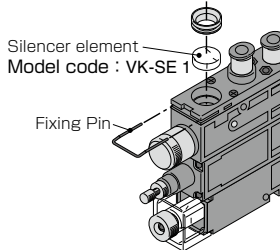

How to replace silencer elements of Manifold Type

How to replace silencer elements of Manifold Type
 · Use a proper screwdriver to remove four tapping screws.

· Remove the element cover and replace silencer elements (Model Code: VKM-SET).

How to mount the silencer element

· Use a screwdriver to tighten the four tapping screws with 0.3-0.4Nm of the tightening torque after the replacement.

※ Silencer element of manifold type consists of VKM-SE1(2pcs) and VKM-SE2(1pce).

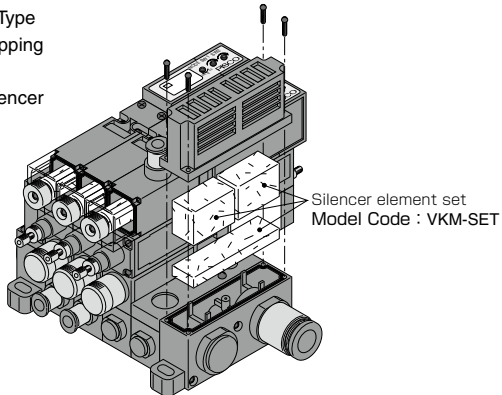

How to attach / detach and clean the nozzle and diffuser

How to attach / detach the nozzle and diffuser

Pull out the diffuser with a pair of long-nose pliers after remove the cover and the diffuser retainer. Use a cushion material such as a sponge to cover the nozzle port to prevent the nozzle from jumping out. Apply the air to the vacuum generator and the nozzle comes out by the air pressure. Take out the cushion material and then take out the nozzle.

※ During applying the air to the generator, do not point the nozzle port toward anyone. There is a risk of injury by the nozzle jumping out.

How to clean the nozzle and diffuser

Remove the substances adhered to the nozzle, diffuser bores and the seal rubber by air blow or wiping.

※ Do not damage nozzle, diffuser bore, seal rubber and the seal part of the body. It may cause performance drop.

How to attach the nozzle and diffuser

Combine the nozzle with the diffuser and push them back into the body with the attention not to drop the nozzle. Place the diffuser retainer on the diffuser and tighten the cover with 0.2-0.25Nm of the tightening torque.

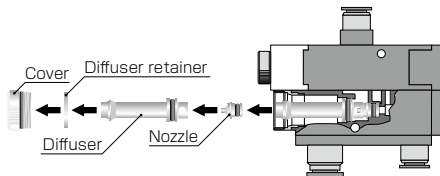



SAFETY Instructions

This safety instructions aim to prevent personal injury and damage to properties by requiring proper use of PISCO products.

Be certain to follow ISO 4414 and JIS B 8370

ISO 4414 : Pneumatic fluid power...Recommendations for the application of equipment to transmission and control systems.

JIS B 8370 : General rules and safety requirements for systems and their components.

This safety instructions is classified into "Danger", "Warning" and "Caution" depending on the degree of danger or damages caused by improper use of PISCO products.



Danger

Hazardous conditions. It can cause death or serious personal injury.



Warning

Hazardous conditions depending on usages. Improper use of PISCO products can cause death or serious personal injury.



Caution

Hazardous conditions depending on usages. Improper use of PISCO products can cause personal injury or damages to properties.



Warning

1. Selection of pneumatic products

- ① A user who is a pneumatic system designer or has sufficient experience and technical expertise should select PISCO products.
- ② Due to wide variety of operating conditions and applications for PISCO products, carry out the analysis and evaluation on PISCO products. The pneumatic system designer is solely responsible for assuring that the user's requirements are met and that the application presents no health or safety hazards. All designers are required to fully understand the specifications of PISCO products and constitute all systems based on the latest catalog or information, considering any malfunctions.

2. Handle the pneumatic equipment with enough knowledge and experience

- ① Improper use of compressed air is dangerous. Assembly, operation and maintenance of machines using pneumatic equipment should be conducted by a person with enough knowledge and experience.

3. Do not operate machine / equipment or remove pneumatic equipment until safety is confirmed.

- ① Make sure that preventive measures against falling work-pieces or sudden movements of machine are completed before inspection or maintenance of these machine.
- ② Make sure the above preventive measures are completed. A compressed air supply and the power supply to the machine must be off, and also the compressed air in the systems must be exhausted.
- ③ Restart the machines with care after ensuring to take all preventive measures against sudden movements.

Disclaimer

1. PISCO does not take any responsibility for any incidental or indirect loss, such as production line stop, interruption of business, loss of benefits, personal injury, etc., caused by any failure on use or application of PISCO products.
2. PISCO does not take any responsibility for any loss caused by natural disasters, fires not related to PISCO products, acts by third parties, and intentional or accidental damages of PISCO products due to incorrect usage.
3. PISCO does not take any responsibility for any loss caused by improper usage of PISCO products such as exceeding the specification limit or not following the usage the published instructions and catalog allow.
4. PISCO does not take any responsibility for any loss caused by remodeling of PISCO products, or by combinational use with non-PISCO products and other software systems.
5. The damages caused by the defect of Pisco products shall be covered but limited to the full amount of the PISCO products paid by the customer.



SAFETY INSTRUCTION MANUAL

PISCO products are designed and manufactured for use in general industrial machines. Be sure to read and follow the instructions below.

⚠ Danger

1. Do not use PISCO products for the following applications.
 - ① Equipment used for maintaining / handling human life and body.
 - ② Equipment used for moving / transporting human.
 - ③ Equipment specifically used for safety purposes.

⚠ Warning

1. Do not use PISCO products under the following conditions.
 - ① Beyond the specifications or conditions stated in the catalog, or the instructions.
 - ② Under the direct sunlight or outdoors.
 - ③ Excessive vibrations and impacts.
 - ④ Exposure / adhere to corrosive gas, inflammable gas, chemicals, seawater, water and vapor. *
* Some products can be used under the condition above(④), refer to the details of specification and condition of each product.
2. Do not disassemble or modify PISCO products, which affect the performance, function, and basic structure of the product.
3. Turn off the power supply, stop the air supply to PISCO products, and make sure there is no residual air pressure in the pipes before maintenance and inspection.
4. Do not touch the release-ring of push-in fitting when there is a working pressure. The lock may be released by the physical contact, and tube may fly out or slip out.
5. Frequent switchover of compressed air may generate heat, and there is a risk of causing burn injury.
6. Avoid any load on PISCO products, such as a tensile strength, twisting and bending. Otherwise, there is a risk of causing damage to the products.
7. As for applications where threads or tubes swing / rotate, use Rotary Joints, High Rotary Joints or Multi-Circuit Rotary Block only. The other PISCO products can be damaged in these applications.
8. Use only Die Temperature Control Fitting Series, Tube Fitting Stainless SUS316 Series, Tube Fitting Stainless SUS316 Compression Fitting Series or Tube Fitting Brass Series under the condition of over 60°C (140° F) water or thermal oil. Other PISCO products can be damaged by heat and hydrolysis under the condition above.
9. As for the condition required to dissipate static electricity or provide an antistatic performance, use EG series fitting and antistatic products only, and do not use other PISCO products. There is a risk that static electricity can cause system defects or failures.
10. Use only Fittings with a characteristic of spatter-proof such as Anti-spatter or Brass series in a place where flame and weld spatter is produced. There is a risk of causing fire by sparks.
11. Turn off the power supply to PISCO products, and make sure there is no residual air pressure in the pipes and equipment before maintenance. Follow the instructions below in order to ensure safety.
 - ① Make sure the safety of all systems related to PISCO products before maintenance.
 - ② Restart of operation after maintenance shall be proceeded with care after ensuring safety of the system by preventive measures against unexpected movements of machines and devices where pneumatic equipment is used.
 - ③ Keep enough space for maintenance when designing a circuit.
12. Take safety measures such as providing a protection cover if there is a risk of causing damages or fires on machine / facilities by a fluid leakage.

⚠ Caution

1. Remove dusts or drain before piping. They may get into the peripheral machine / facilities and cause malfunction.
2. When inserting an ultra-soft tube into push-in fitting, make sure to place an Insert Ring into the tube edge. There is a risk of causing the escape of tube and a fluid leakage without using an Insert Ring.
3. The product incorporating NBR as seal rubber material has a risk of malfunction caused by ozone crack. Ozone exists in high concentrations in static elimination air, clean-room, and near the high-voltage motors, etc. As a countermeasure, material change from NBR to HNBR or FKM is necessary. Consult with PISCO for more information.
4. Special option "Oil-free" products may cause a very small amount of a fluid leakage. When a fluid medium is liquid or the products are required to be used in harsh environments, contact us for further information.
5. In case of using non-PISCO brand tubes, make sure the tolerance of the outer tube diameter is within the limits of Table 1.

● Table 1. Tube O.D. Tolerance

mm size	Nylon tube	Polyurethane tube	inch size	Nylon tube	Polyurethane tube
ø1.8mm	—	± 0.05mm	ø1/8	± 0.1mm	± 0.15mm
ø3mm	—	± 0.15mm	ø5/32	± 0.1mm	± 0.15mm
ø4mm	± 0.1mm	± 0.15mm	ø3/16	± 0.1mm	± 0.15mm
ø6mm	± 0.1mm	± 0.15mm	ø1/4	± 0.1mm	± 0.15mm
ø8mm	± 0.1mm	± 0.15mm	ø5/16	± 0.1mm	± 0.15mm
ø10mm	± 0.1mm	± 0.15mm	ø3/8	± 0.1mm	± 0.15mm
ø12mm	± 0.1mm	± 0.15mm	ø1/2	± 0.1mm	± 0.15mm
ø16mm	± 0.1mm	± 0.15mm	ø5/8	± 0.1mm	± 0.15mm

6. Instructions for Tube Insertion

- ① Make sure that the cut end surface of the tube is at right angle without a scratch on the surface and deformations.
- ② When inserting a tube, the tube needs to be inserted fully into the push-in fitting until the tubing edge touches the tube end of the fitting as shown in the figure below. Otherwise, there is a risk of leakage.

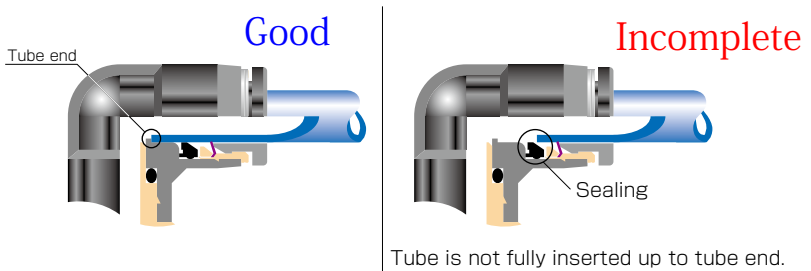

- ③ After inserting the tube, make sure it is inserted properly and not to be disconnected by pulling it moderately.
- ※ When inserting tubes, Lock-claws may be hardly visible in the hole, observed from the front face of the release-ring. But it does not mean the tube will surely escape. Major causes of the tube escape are the followings;
 - ① Shear drop of the lock-claws edge
 - ② The problem of tube diameter (usually small)
 Therefore, follow the above instructions from ① to ③, even lock-claws is hardly visible.

7. Instructions for Tube Disconnection

- ① Make sure there is no air pressure inside of the tube, before disconnecting it.
- ② Push the release-ring of the push-in fitting evenly and deeply enough to pull out the tube toward oneself. By insufficient pushing of the release-ring, the tube may not be pulled out or damaged by scratch, and tube shavings may remain inside of the fitting, which may cause the leakage later.

8. Instructions for Installing a fitting

- ① When installing a fitting, use proper tools to tighten a hexagonal-column or an inner hexagonal socket. When inserting a hex key into the inner hexagonal socket of the fitting, be careful so that the tool does not touch lock-claws. The deformation of lock-claws may result in a poor performance of systems or an escape of the tube.
- ② Refer to Table 2 which shows the recommended tightening torque. Do not exceed these limits to tighten a thread. Excessive tightening may break the thread part or deform the gasket and cause a fluid leakage. Tightening thread with tightening torque lower than these limits may cause a loosened thread or a fluid leakage.
- ③ Adjust the tube direction while tightening thread within these limits, since some PISCO products are not rotatable after the installation.

● Table 2: Recommended tightening torque / Sealock color / Gasket materials

Thread type	Thread size	Tightening torque	Sealock color	Gasket materials
Metric thread	M3 × 0.5	0.7N·m	—	SUS304 NBR
	M5 × 0.8	1.0 ~ 1.5N·m		
	M6 × 1	2 ~ 2.7N·m		
	M3 × 0.5	0.7N·m		POM
	M5 × 0.8	1 ~ 1.5N·m		
	M6 × 0.75	0.8 ~ 1N·m		
Taper pipe thread	M8 × 0.75	1 ~ 2N·m	White	—
	R1/8	4.5 ~ 6.5N·m		
	R1/4	7 ~ 9N·m		
	R3/8	12.5 ~ 14.5N·m		
Unified thread	R1/2	20 ~ 22N·m	—	SUS304, NBR
	No.10-32UNF	1.0 ~ 1.5N·m		
National pipe thread taper	1/16-27NPT	4.5 ~ 6.5N·m	White	—
	1/8-27NPT	4.5 ~ 6.5N·m		
	1/4-18NPT	7 ~ 9N·m		
	3/8-18NPT	12.5 ~ 14.5N·m		
	1/2-14NPT	20 ~ 22N·m		

※ These values may differ for some products. Refer to each specification as well.

9. Instructions for removing a fitting

- ① When removing a fitting, use proper tools to loosen a hexagonal-column or an inner hex bolt.
- ② Remove the sealant stuck on the mating equipment. The remained sealant may get into the peripheral equipment and cause malfunctions.

10. Arrange piping avoiding any load on fittings and tubes such as twist, tensile, moment load, shaking and physical impact. These may cause damages to fittings, tube deformations, bursting and the escape of tubes.



Common Safety Instructions for Vacuum Series

Before selecting or using PISCO products, read the following instructions. Read the detailed instructions for individual series.

Warning

1. If there is a risk of dropping work-pieces during vacuum suction, take a safety measure against the falling of them.
2. Avoid supplying more than 0.1MPa pressure constantly in a vacuum circuit. Since vacuum generators are not explosive-proof, there is a risk of damaging the products.
3. Pay attention to drop of vacuum pressure caused by problems of the supplied air or the power supply. Decrease of suction force may lead to a danger of falling work-piece so that safety measure against the falling of them is necessary.
4. When more than 2 vacuum pads are plumbed on a single ejector and one of them has a suction problem such as vacuum leak, there is a risk of releasing work-pieces from the other pad due to the drop of the vacuum pressure.
5. Do not use in the way by which exhaust port is blocked or exhaust resistance is increased. Otherwise, there is a risk of no vacuum generation or a drop of the vacuum pressure.
6. Do not use the product in the circumstance of corrosive gas, inflammable gas, explosive gas, chemicals, seawater and vapor or do not expose the product to those. Never allow the product to suck those things.
7. Provide a protective cover on the products when it is exposed to sunlight.
8. Carry out clogging check for silencer element in an ejector and a vacuum filter periodically. Clogged element will be a cause to impair the performance or a cause of troubles.
9. Before replacing the element, thoroughly read and understand the method of filter replacement in the catalog.
10. Make sure the correct port of the vacuum generator by this catalog or marking on the products when plumbing. Wrong plumbing can be a risk to damage the product.
11. Supply clean air without sludge or dusts to an ejector. Do not lubricate by a lubricator. There is a risk of malfunction or performance impairing by impurities and oil contained in the compressed air.
12. Do not apply extreme tension, twist or bending forces on a lead wire. Otherwise, it may cause a wire breaking.
13. Locknut needs to be tightened firmly by hand. Do not use any tool to tighten. In case of using tools to tighten the locknut, it may damage the locknut or the product. Inadequate tightening may loosen the locknut and the initial setting can be changed.
14. Do not force the product to rotate or swing even its resin body is rotatable. It may cause damage to the product and a fluid leakage.
15. Do not supply an air pressure or a dry air to the products over the necessary amount. There is a risk of deteriorating rubber materials and malfunction due to oil.
16. Keep the product away from water, oil drops or dusts. These may cause malfunction. Take a proper measure to protect the product before the operation.

17. Do not use the product in the environment of inflammable or explosive gas / fluid. It can cause a fire or an explosion hazard.
18. Do not use the product in the circumstance of corrosive gas, inflammable gas, explosive gas, chemicals, seawater and vapor or do not expose the product to those. Otherwise, it may be a cause of malfunction.
19. Do not clean or paint the products by water or a solvent.

Caution

1. Operating pressure range in the catalog is the values during ejector operation. Secure the described value of the supplied air, taking a drop of the pressure into consideration. Insufficient pressure, which does not satisfy the spec, may cause abnormal noise, unstable performance and may negatively affect sensors, bringing troubles at last.
2. Effective cross-section area of the air supply side needs to be three times as large as effective cross-section area of the nozzle bore. When arranging piping or selecting PISCO products, secure required effective cross-section area. Insufficient supply pressure may be a cause to impair performance.
3. A Shorter distance of plumbing with a wider bore is preferable at vacuum system side. A long plumbing with a small bore may result in slow response time at the time of releasing work-piece as well as in failure to secure adequate suction flow rate.
4. Plumb a vacuum switch and an ejector with vacuum switch at the end of vacuum system as much as possible. A long distance between a vacuum switch and a vacuum system end may increase plumbing resistance which may lead to a high vacuum level at the sensor even when no suctioning and a malfunction of vacuum switch. Make sure to evaluate the products in an actual system.
5. Refer to "4. Instructions for Installing a fitting" and "5. Instructions for Removing a fitting" under "Common Safety Instructions for Fittings" , when installing or removing Fittings.
6. Refer to "Common Safety Instructions for Pressure Sensors" and "Detailed Safety Instructions" for the handling of digital vacuum switch sensor.
7. Refer to "Common Safety Instructions for Mechanical Vacuum Sensor" for the handling of mechanical vacuum switch.
8. The material of plastic filter cover for VG, VK, VJ, VZ and VX series is PCTG. Avoid the adherence of Chemicals below to the products, and do not use them under those chemical environments.

● Table Chemical Name

Chemical Name
Thinner
Carbon tetrachloride
Chloroform
Acetate
Aniline
Cyclohexane
Trichloroethylene
Sulfuric acid
Lactic acid
Water soluble cutting oil (alkaline)

* There are more chemicals which should be avoided. Contact us for the use under chemical circumstance.

Vacuum Generator

9. The material of plastic filter cover for VQ and VFU series is PA. Avoid the adherence of chemicals below to the products, and do not use them under those chemical environments.

● Table Chemical Name

Chemical Name
Methanol
Ethanol
Nitric acid
Sulfuric acid
Hydrochloric acid
Lactic acid
Acetone
Chloroform
Aniline
Trichloroethylene
Hydrogen peroxide

* There are more chemicals which should be avoided. Contact us for the use under chemical circumstance.



Common Safety Instructions for Vacuum Generator VG and VK Series

Before selecting or using PISCO products, read the following instructions. Read the detailed instructions for individual series.

Warning

1. For the operation of the valve, make sure that the leakage current is less than 1mA. Leakage current larger than that may cause malfunction.
2. The Vacuum Generator with retention function or check valve function permits some vacuum leakage, so provide an appropriate safety measure when vacuum retention for long period of time is required.
3. Long continuous power supply to the valve may raise the temperature of the coil. Heat may cause damaging product life, malfunction, and burns or may adversely affect the peripheral machines. Consult PISCO about such applications.

Caution

1. Do not give an excessive tensile strength and bending on a lead wire. Otherwise, breaking wire or damage on connector may be caused.
2. When manifold type is selected, dropping the performance or having an effect to other vacuum ports can be caused depending on number of stations or a combination of mounting units. Contact us for any unclear points.
3. Compressed air contains many kinds of drains such as water, oxidized oil, tar and other foreign substances. Dehumidify the compressed air by using an after-cooler or a dryer and improve the air quality, since those drains seriously impair the performance of the vacuum generator.
4. Do not use lubricators.
5. Since pipe rust cause malfunctions, a filter finer than 5 μ m should be placed right before the air supply port.
6. Do not use the vacuum generator under the condition of corrosive and/or flammable gases. Also do not use these gasses as a fluid medium.
7. Do not operate blow-off solenoid valve during vacuum generating.
8. When replacing vacuum port cartridge, first remove any foreign matter clinging to them and the surrounding areas, then firmly insert pins into cartridges.
9. For handling and setting of vacuum switch, please read instruction manual carefully.
10. For adjustment of vacuum blow-off air flow or blow-off time of air-timer operated blow-off valve on VK Series, read the instructions carefully.